

SERIVICE MANUAL

AR - AIR CONDICIONER DC INVERTER SPLIT WALL-MOUNTED TYPE Serie ALFA (MSH) R 410 a



TYPE
MSH-07HRDN1
MSH-09HRDN1
MSH-12HRDN1

AR 07670 Porto Colom c / Asuncion 19 bajos Tel:0034-971.825.962 info@climabalear.com

CONTENTS

1. Precaution	1
1.1 Safety Precaution	1
1.2 Warning	1
2. Function	4
3. Dimension	6
3.1 Indoor Unit.....	6
MSC-09HRDN1-QC2(B) MSC-12HRDN1-QC2(B).....	6
MSH-09HRDN1-QC2(B) MSH-12HRDN1-QC2(B).....	6
3.2 Outdoor Unit	7
MOC4-09HDN1-QC2 MOC4-12HDN1-QC2	7
4. Specification	8
5. Refrigerant cycle diagram	10
6. Wiring diagram	11
6.1 Indoor Unit.....	11
MSC-09HRDN1-QC2(B) MSC-12HRDN1-QC2(B).....	11
MSH-09HRDN1-QC2(B) MSH-12HRDN1-QC2(B).....	11
6.2 Outdoor Unit	11
MOC4-09HDN1-QC2 MOC4-12HDN1-QC2	12
7. Installation details	13
7.1 Wrench torque sheet for installation	13
7.2 Connecting the cables	13
7.3 Pipe length and the elevation	13
7.4 Air purging of the piping and indoor unit.....	13
7.5 Pumping down (Re-installation).....	15
7.6 Re-air purging (Re-installation).....	16
7.7 Balance refrigerant of the 2-way, 3-way valves	17
7.8 Evacuation.....	18
7.9 Gas charging.....	19
8. Operation characteristics	20
8.1 MSC-09HRDN1-QC2(B).....	20
8.2 MSC-12HRDN1-QC2(B).....	21
8.3 MSH-09HRDN1-QC2(B).....	22
8.4 MSH-12HRDN1-QC2(B).....	23
9. Electronic function	24
9.1 Abbreviation.....	24
9.2 Display function	24
9.3 Protection	25
9.4 Fan-Only Mode.....	25
9.5 Cooling Mode	26
9.6 Drying mode	27
9.7 Heating mode.....	27
9.8 Auto mode function.....	30

9.9	Forced operation function.....	31
9.10	Action of 4-way valve.....	31
9.11	Two speeds outdoor fan function.....	31
9.12	Timer function.....	31
9.13	Sleep function mode.....	32
9.14	Auto-Restart function.....	32
9.15	Ionizer/Plasma dust collector function(optional).....	32
9.16	Outdoor chassis heating cable (optional).....	32
10.	Troubleshooting.....	33
10.1	Indoor Unit Error Display.....	34
10.2	Diagnosis and Solution.....	35
10.3	Key parts checking.....	38

1. Precaution

1.1 Safety Precaution

■ **To prevent injury to the user or other people and property damage, the following instructions must be followed.**

■ **Incorrect operation due to ignoring instruction will cause harm or damage.**

■ **Before service unit, be sure to read this service manual at first.**

1.2 Warning

➤ Installation

■ **Do not use a defective or underrated circuit breaker. Use this appliance on a dedicated circuit.**

There is risk of fire or electric shock.

■ **For electrical work, contact the dealer, seller, a qualified electrician, or an Authorized service center.**

Do not disassemble or repair the product, there is risk of fire or electric shock.

■ **Always ground the product.**

There is risk of fire or electric shock.

■ **Install the panel and the cover of control box securely.**

There is risk of fire or electric shock.

■ **Always install a dedicated circuit and breaker.**

Improper wiring or installation may cause fire or electric shock.

■ **Use the correctly rated breaker or fuse.**

There is risk of fire or electric shock.

■ **Do not modify or extend the power cable.**

There is risk of fire or electric shock.

■ **Do not install, remove, or reinstall the unit by yourself(customer).**

There is risk of fire, electric shock, explosion, or injury.

■ **Be caution when unpacking and installing the product.**

Sharp edges could cause injury, be especially careful of the case edges and the fins on the condenser and evaporator.

■ **For installation, always contact the dealer or an Authorized service center.**

There is risk of fire, electric shock, explosion, or injury.

■ **Do not install the product on a defective**

installation stand.

It may cause injury, accident, or damage to the product.

■ **Be sure the installation area does not deteriorate with age.**

If the base collapses, the air conditioner could fall with it, causing property damage, product failure, and personal injury.

■ **Do not let the air conditioner run for a long time when the humidity is very high and a door or a window is left open.**

Moisture may condense and wet or damage furniture.

■ **Take care to ensure that power cable could not be pulled out or damaged during operation.**

There is risk of fire or electric shock.

■ **Do not place anything on the power cable.**

There is risk of fire or electric shock.

■ **Do not plug or unplug the power supply plug during operation.**

There is risk of fire or electric shock.

■ **Do not touch (operation) the product with wet hands.**

There is risk of fire or electric shock.

■ **Do not place a heater or other appliance near the power cable.**

There is risk of fire and electric shock.

■ **Do not allow water to run into electric parts.**

It may cause fire, failure of the product, or electric shock.

■ **Do not store or use flammable gas or combustible near the product.**

There is risk of fire or failure of product.

■ **Do not use the product in a tightly closed space for a long time.**

Oxygen deficiency could occur.

■ **When flammable gas leaks, turn off the gas and open a window for ventilation before turn the product on.**

Do not use the telephone or turn switches on or off. There is risk of explosion or fire.

■ **If strange sounds, or small or smoke comes from product. Turn the breaker off or disconnect the power supply cable.**

There is risk of electric shock or fire.

■ **Stop operation and close the window in storm or hurricane. If possible, remove the product from the window before the hurricane**

arrives.

There is risk of property damage, failure of product, or electric shock.

■ **Do not open the inlet grill of the product during operation. (Do not touch the electrostatic filter, if the unit is so equipped.)**

There is risk of physical injury, electric shock, or product failure.

■ **When the product is soaked (flooded or submerged), contact an Authorized service center.**

There is risk of fire or electric shock.

■ **Be caution that water could not enter the product.**

There is risk of fire, electric shock, or product damage.

■ **Ventilate the product from time to time when operating it together with a stove, etc.**

There is risk of fire or electric shock.

■ **Turn the main power off when cleaning or maintaining the product.**

There is risk of electric shock.

■ **When the product is not be used for a long time, disconnect the power supply plug or turn off the breaker.**

There is risk of product damage or failure, or unintended operation.

■ **Take care to ensure that nobody could step on or fall onto the outdoor unit.**

This could result in personal injury and product damage.

➤ CAUTION

■ **Always check for gas (refrigerant) leakage after installation or repair of product.**

Low refrigerant levels may cause failure of product.

■ **Install the drain hose to ensure that water is drained away properly.**

A bad connection may cause water leakage.

■ **Keep level even when installing the product.**

To avoid vibration of water leakage.

■ **Do not install the product where the noise or hot air from the outdoor unit could damage the neighborhoods.**

It may cause a problem for your neighbors.

■ **Use two or more people to lift and transport the product.**

Avoid personal injury.

■ **Do not install the product where it will be exposed to sea wind (salt spray) directly.**

It may cause corrosion on the product. Corrosion, particularly on the condenser and evaporator fins, could cause product malfunction or inefficient operation.

➤ Operational

■ **Do not expose the skin directly to cool air for long periods of time. (Do not sit in the draft).**

This could harm to your health.

■ **Do not use the product for special purposes, such as preserving foods, works of art, etc. It is a consumer air conditioner, not a precision refrigerant system.**

There is risk of damage or loss of property.

■ **Do not block the inlet or outlet of air flow.**

It may cause product failure.

■ **Use a soft cloth to clean. Do not use harsh detergents, solvents, etc.**

There is risk of fire, electric shock, or damage to the plastic parts of the product.

■ **Do not touch the metal parts of the product when removing the air filter. They are very sharp.**

There is risk of personal injury.

■ **Do not step on or put anything on the product. (outdoor units)**

There is risk of personal injury and failure of product.

■ **Always insert the filter securely. Clean the filter every two weeks or more often if necessary.**

A dirty filter reduces the efficiency of the air conditioner and could cause product malfunction or damage.

■ **Do not insert hands or other object through air inlet or outlet while the product is operated.**

There are sharp and moving parts that could cause personal injury.

■ **Do not drink the water drained from the product.**

It is not sanitary could cause serious health issues.

■ **Use a firm stool or ladder when cleaning or maintaining the product.**

Be careful and avoid personal injury.

■ **Replace the all batteries in the remote control with new ones of the same type. Do not mix old and new batteries or different types of batteries.**

There is risk of fire or explosion.

■ **Do not recharge or disassemble the batteries. Do not dispose of batteries in a fire.**

They may burn or explode.

■ **If the liquid from the batteries gets onto**

your skin or clothes, wash it well with clean water. Do not use the remote of the batteries have leaked.

The chemical in batteries could cause burns or other health hazards

2. Function

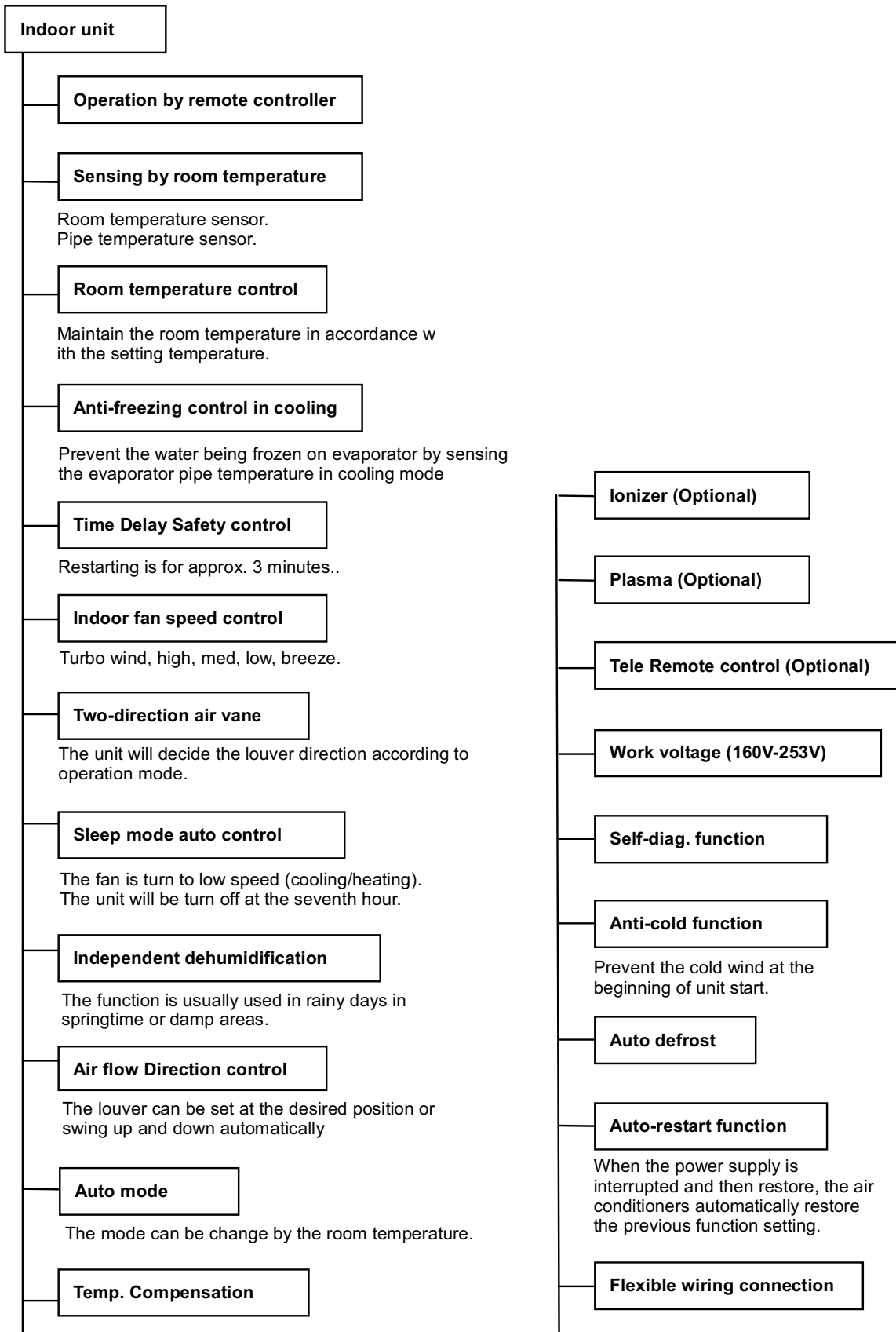

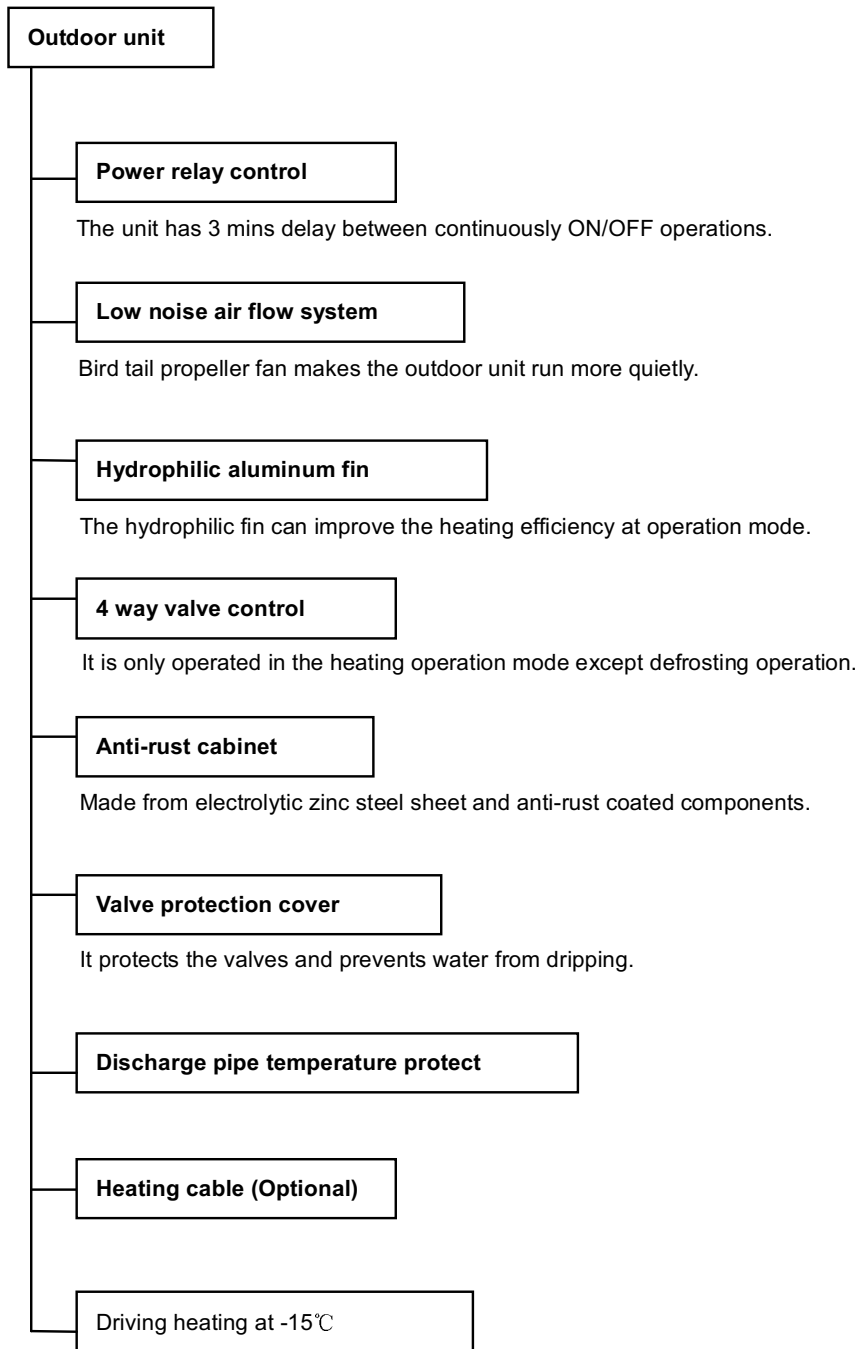

3. Dimension

3.1 Indoor Unit

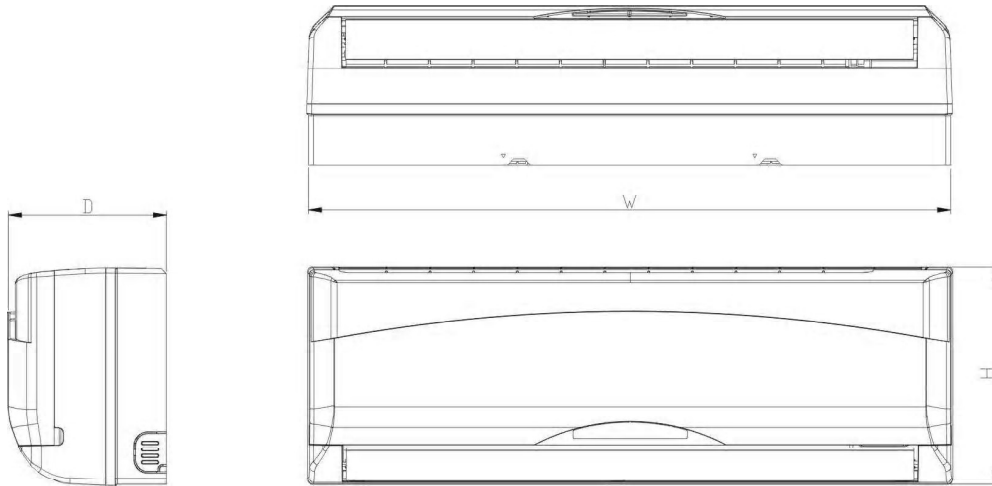

Model	W(mm)	H(mm)	D(mm)
MSC-09HRDN1-QC2(B)	710	250	195
MSC-12HRDN1-QC2(B)	790	265	195

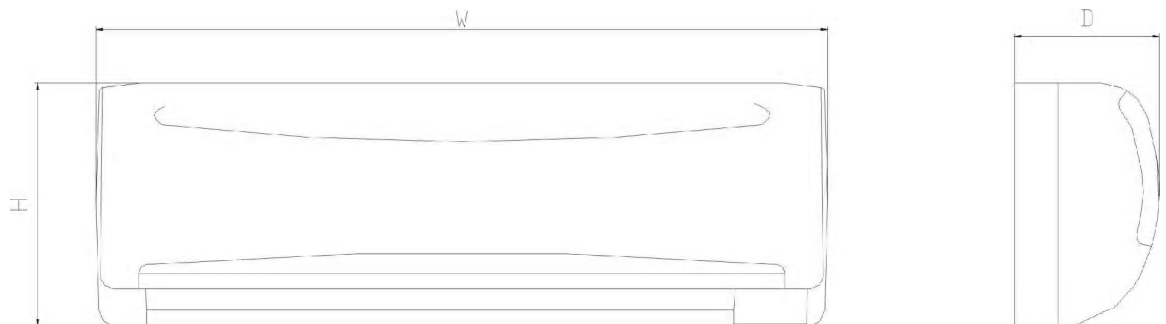

Model	W(mm)	H(mm)	D(mm)
MSH-09HRDN1-QC2(B)	750	250	205
MSH-12HRDN1-QC2(B)	815	280	215

3.2 Outdoor Unit

MOC4-09HDN1-QC2

MOC4-12HDN1-QC2

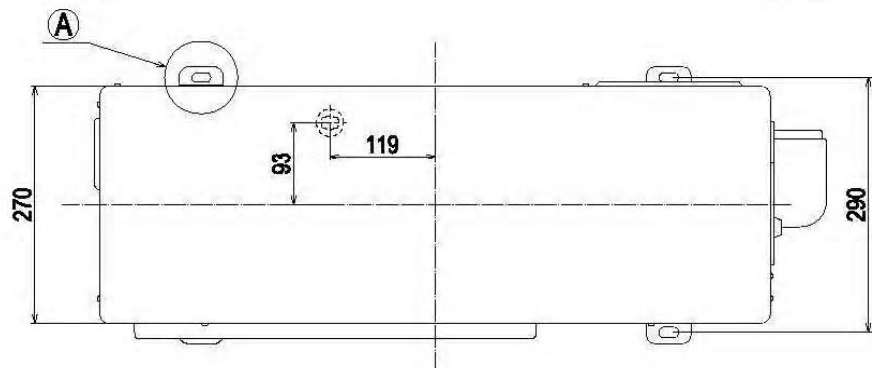
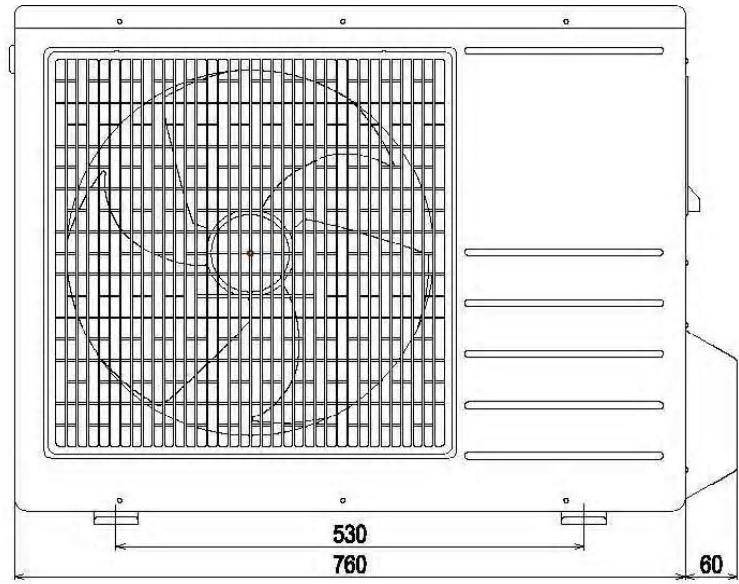
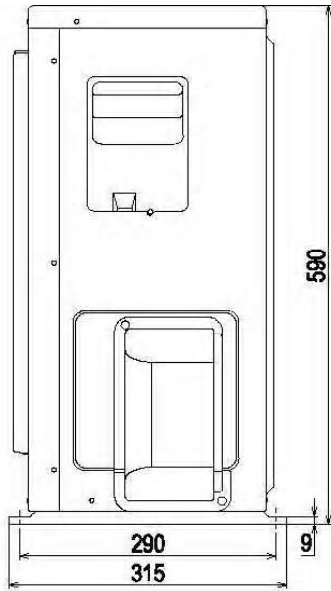

Gas side
(Flare $\Phi 9.53$ for 9K model
 $\Phi 12.7$ for 12K model)

Service port

Liquid side (Flare $\Phi 6.35$)

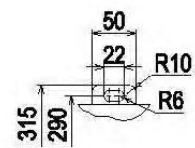
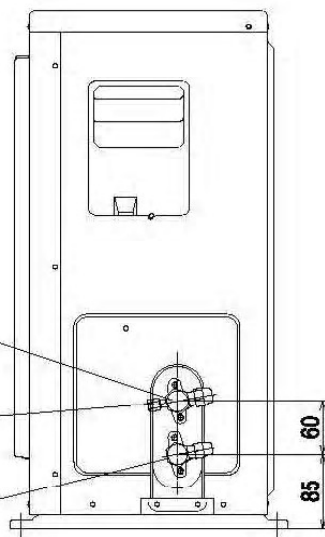

Ⓐ Detail Drawing for Leg

4. Specification

Indoor			MSC-09HRDN1-QC2(B)	MSC-12HRDN1-QC2(B)
Outdoor			MOC4-09HDN1-QC2	MOC4-12HDN1-QC2
Power supply		Ph-V-Hz	1,220-240V~, 50Hz	1, 220-240V~, 50Hz
Cooling	Capacity	Btu/h	9000(2050~11200)	12000(4000~13800)
	Input	W	810(240~1080)	1080(350~1400)
	Rated current	A	3.8(1.2~5.4)	4.9(1.7~6.5)
	EER	Btu/w.h, w/w	11.1,3.26	11.1,3.26
Heating	Capacity	Btu/h	10000(3200~13200)	13000(4100~14500)
	Input	W	810(240~1340)	1050(360~1420)
	Rated current	A	3.8(1.2~6.1)	4.7(1.8~6.6)
	COP	W/W	3.62	3.63
Moisture Removal		L/h	1.0	1.2
Max. input consumption		W	1900	2550
Max. current		A	10	12
Starting current		A	5.7	7.3
Compressor	Model		DA108X1C-20FZ3	DA108X1C-20FZ3
	Type		Rotary	Rotary
	Brand		TOSHIBA	TOSHIBA
	Capacity	Btu/h	10900	10900
	Input	W	855	855
	Rated current(RLA)	A	5.3	5.3
	Locked rotor Amp(LRA)	A	10	10
	Thermal protector		CS-74	CS-74
	Capacitor	uF	No	No
	Refrigerant oil	ml	480	480
Indoor fan motor	Model		RPG18H	RPG20D
	Brand		Welling	Welling
	Input	W	36	38
	Capacitor	uF	1.2	1.5
	Speed(hi/mi/lo)	r/min	1250/1100/880	1250/1050/900
Indoor air flow (Hi/Mi/Lo)		m3/h	570/480/350	615/485/325
Indoor noise level (Hi/Mi/Lo)		dB(A)	39/33/28	40/35/29
Indoor unit	Dimension (W*H*D)	mm	710*250*195	790*265*195
	Packing (W*H*D)	mm	800*340*270	875*375*285
	Net/Gross weight	Kg	8.0/10.0	9.0/11.0
Outdoor fan motor	Model		YDK24-6G	YDK24-6G
	Brand		Welling	Welling
	Input	W	59	59
	Capacitor	uF	2.5	2.5
	Speed	r/min	800/550	800/550
Outdoor air flow		m3/h	1800	1800
Outdoor noise level		dB(A)	52	54
Outdoor unit	Dimension(W*H*D)	mm	760*590*285	760*590*285
	Packing (W*H*D)	mm	887*655*355	887*655*355
	Net/Gross weight	Kg	37.5/40.5	39.5/42.5
Refrigerant type R410A		g	750	1000
Refrigerant piping	Liquid side/ Gas side	mm(inch)	Φ6.35/Φ9.53	Φ6.35/Φ12.7
	Max. refrigerant pipe length	m	20	20
	Max. difference in level	m	8	8
Operation temp		℃	17 ~ 30	17 ~ 30
Ambient temp		℃	-15 ~ 50	-15 ~ 50

Indoor			MSH-09HRDN1-QC2(B)	MSH-12HRDN1-QC2(B)
Outdoor			MOC4-09HDN1-QC2	MOC4-12HDN1-QC2
Power supply		Ph-V-Hz	1,220-240V~,50Hz	1,220-240V~, 50Hz
Cooling	Capacity	Btu/h	9000(3100~11400)	12000(4000~13800)
	Input	W	800(230~1080)	1080(350~1400)
	Rated current	A	3.7(1.2~5.4)	4.9(1.7~6.5)
	EER	Btu/w.h, w/w	11.2,3.30	11.1,3.26
Heating	Capacity	Btu/h	10000(3200~13500)	13000(4100~14500)
	Input	W	810(240~1380)	1050(360~1420)
	Rated current	A	3.8(1.2~6.2)	4.7(1.8~6.6)
	COP	W/W	3.62	3.63
Moisture Removal		L/h	1.0	1.2
Max. input consumption		W	1900	2550
Max. current		A	10	12
Starting current		A	5.5	7.3
Compressor	Model		DA108X1C-20FZ3	DA108X1C-20FZ3
	Type		Rotary	Rotary
	Brand		TOSHIBA	TOSHIBA
	Capacity	Btu/h	10900	10900
	Input	W	855	855
	Rated current(RLA)	A	5.3	5.3
	Locked rotor Amp(LRA)	A	10	10
	Thermal protector		CS-74	CS-74
	Capacitor	uF	No	No
Refrigerant oil	ml	480	480	
Indoor fan motor	Model		RPG18H	RPG20D
	Brand		Welling	Welling
	Input	W	36	38
	Capacitor	uF	1.2	1.5
	Speed(hi/mi/lo)	r/min	1200/1000/850	1250/1060/800
Indoor air flow (Hi/Mi/Lo)		m3/h	570/480/350	675/520/375
Indoor noise level (Hi/Mi/Lo)		dB(A)	39/33/28	40/35/29
Indoor unit	Dimension (W*H*D)	mm	750*250*205	815*280*215
	Packing (W*H*D)	mm	830*335*285	915*360*290
	Net/Gross weight	Kg	8.0/10.0	9.5/11.5
Outdoor fan motor	Model		YDK24-6G	YDK24-6G
	Brand		Welling	Welling
	Input	W	59	59
	Capacitor	uF	2.5	2.5
	Speed	r/min	800/550	800/550
Outdoor air flow		m3/h	1800	1800
Outdoor noise level		dB(A)	52	54
Outdoor unit	Dimension(W*H*D)	mm	760*590*285	760*590*285
	Packing (W*H*D)	mm	887*655*355	887*655*355
	Net/Gross weight	Kg	37.5/40.5	39.5/42.5
Refrigerant type R410A		g	750	1000
Refrigerant piping	Liquid side/ Gas side	mm(inch)	Φ6.35/Φ9.53	Φ6.35/Φ12.7
	Max. refrigerant pipe length	m	20	20
	Max. difference in level	m	8	8
Operation temp		℃	17 ~ 30	17 ~ 30
Ambient temp		℃	-15 ~ 50	-15 ~ 50

The above design and specifications are subject to change without prior notice for product improvement.

5. Refrigerant cycle diagram

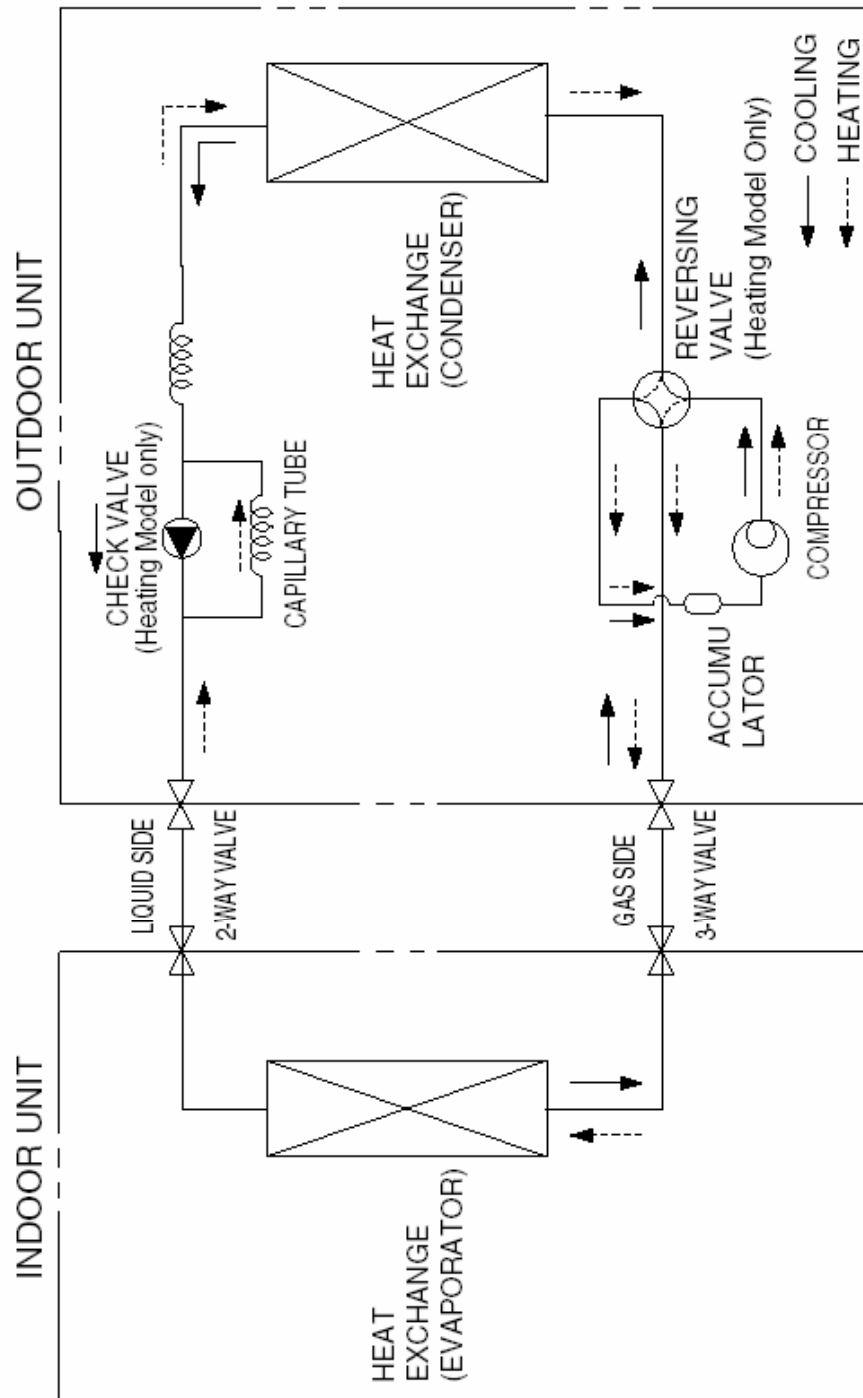

6. Wiring diagram

6.1 Indoor Unit

MSC-09HRDN1-QC2(B)

MSC-12HRDN1-QC2(B)

MSH-09HRDN1-QC2(B)

MSH-12HRDN1-QC2(B)

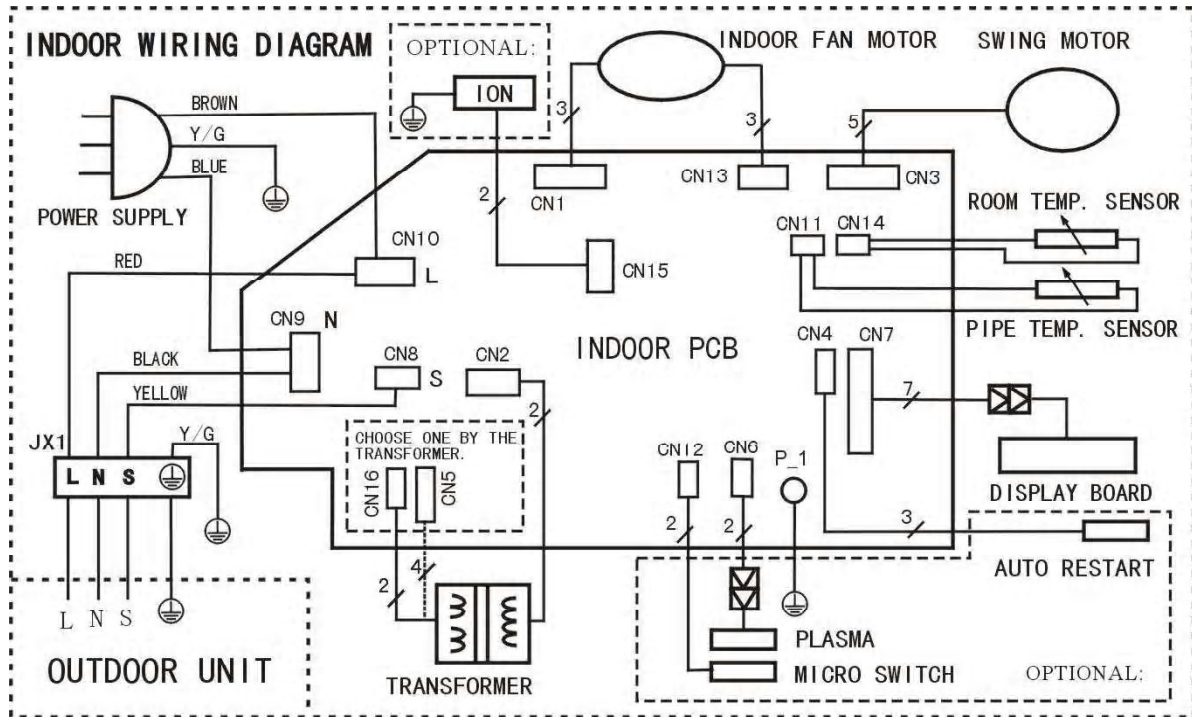

6.2 Outdoor Unit

MOC4-09HDN1-QC2 MOC4-12HDN1-QC2

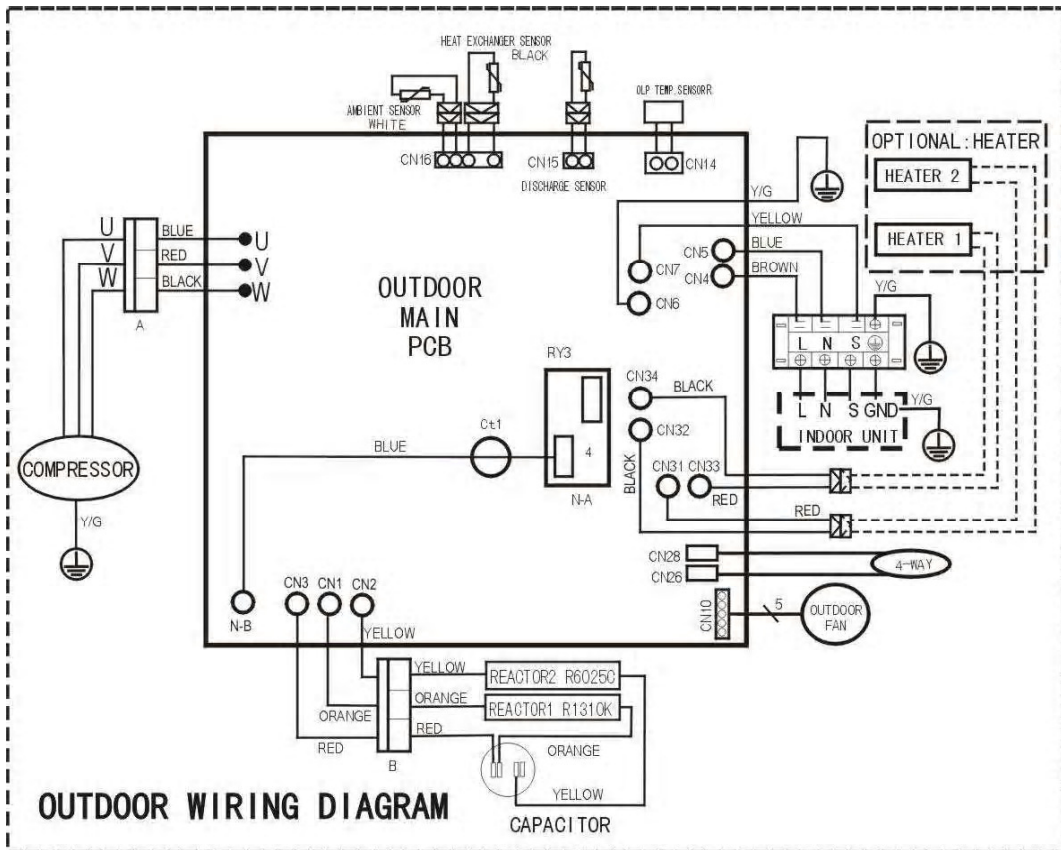

7. Installation details

7.1 Wrench torque sheet for installation

Outside diameter		Torque
mm	inch	Kgf. m
Φ6.35	1/4	1.8
Φ9.52	3/8	4.2
Φ12.7	1/2	5.5

7.2 Connecting the cables

The power cord of connect should be selected according to the following specifications sheet.

Unit	Grade	
	9K	12K
mm ²	1.5	1.5

7.3 Pipe length and the elevation

Capacity Btu/h	Pipe size		Standard length (m)	Max. Elevation B (m)	Max. Length A (m)	Additional refrigerant (g/m)
	Gas	Liquid				
9k	3/8" (Φ9.52)	1/4" (Φ6.35)	5	8	20	30
12k	1/2" (Φ12.7)	1/4" (Φ6.35)	5	8	20	30

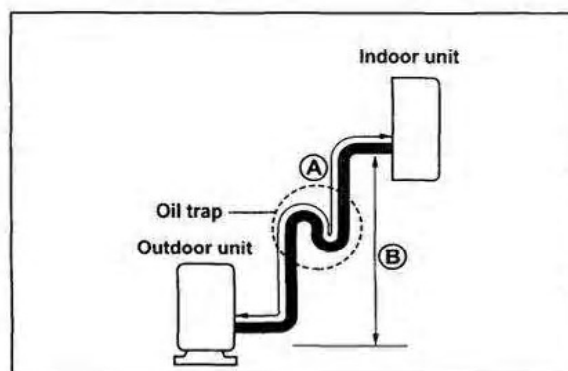
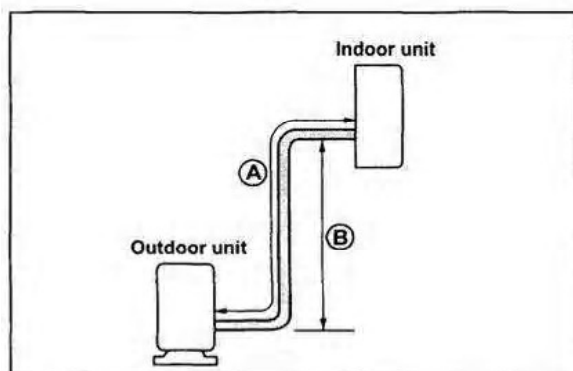

Caution:

Capacity is base on standard length and maximum allowance length is base of reliability.

Oil trap should be installed per 5-7 meters.

7.4 Air purging of the piping and indoor unit

Required tools:

Hexagonal wrench; adjustable wrench; torque wrenches, wrench to hold the joints and gas leak detector.

Note:

The air in the indoor unit and in the piping must be purged. If air remains in the refrigeration piping, it will affect the

compressor, reduce the cooling capacity, and could lead to a malfunction of unit.

Be sure, using a torque wrench to tighten the service port cap (after using the service port), so that it prevents the gas leakage from the refrigeration cycle.

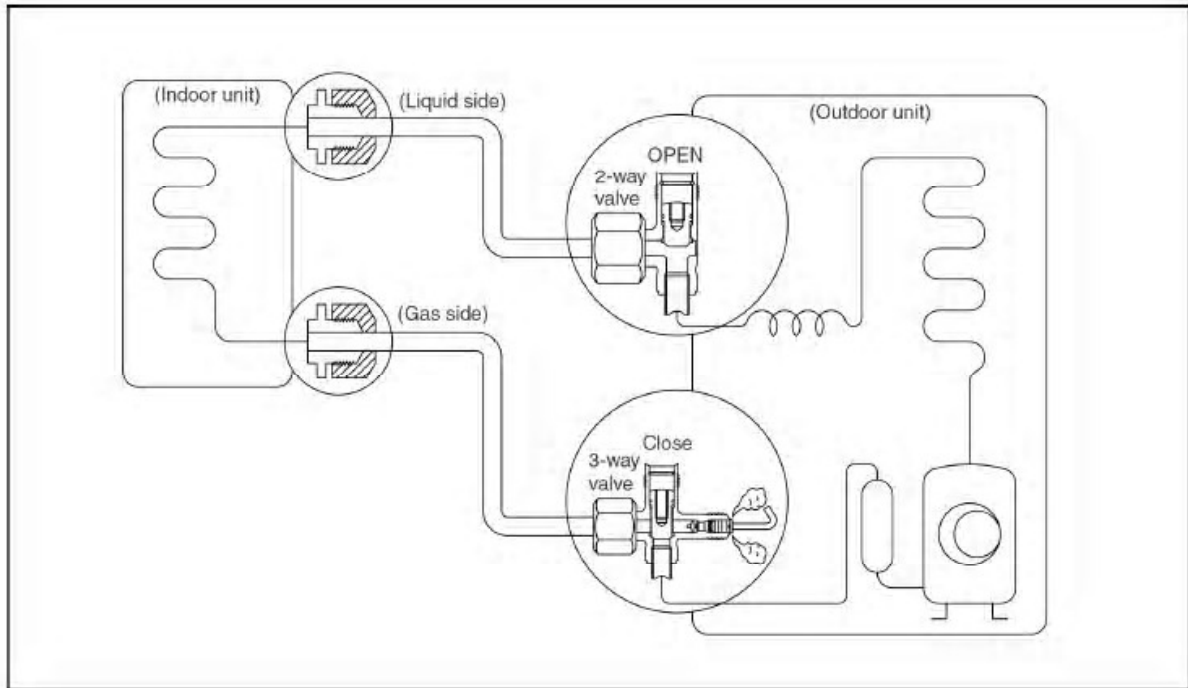

Procedure

1. Recheck the piping connections.
2. Open the valve stem of the 2-way valve counterclockwise approximately 90°, wait 10 seconds, and then set it to closed position.
Be sure to use a hexagonal wrench to operate the valve stem.
3. Check for gas leakage.
Check the flare connection for gas leakage
4. Purge the air from the system.
Set the 2-way valve to the open position and remove the cap from the 3-way valve's service port.
Using the hexagonal wrench to press the valve core pin, discharge for three seconds and then wait for one minute.
5. Use torque wrench to tighten the service port cap to a torque of 1.8 kgf.m. (18n.m)
6. Set the 3-way valve to the opened position.
7. Mounted the valve stem nuts to the 2-way and 3-way valves.
8. Check for gas leakage.
At this time, especially check for gas leakage from the 2-way and 3-way stem nuts, and from the

service port.

Caution:

If gas leakage is discovered in step (3) above, take the following measures.

If the leaks stop when the piping connections are tightened further, continue working from step (4).

If the gas leaks do not stop when the connections are retightened, repair the location of the leak, discharge all of the gas through the service port, and then recharge with the specified amount of gas from a gas cylinder.

7.5 Pumping down (Re-installation)

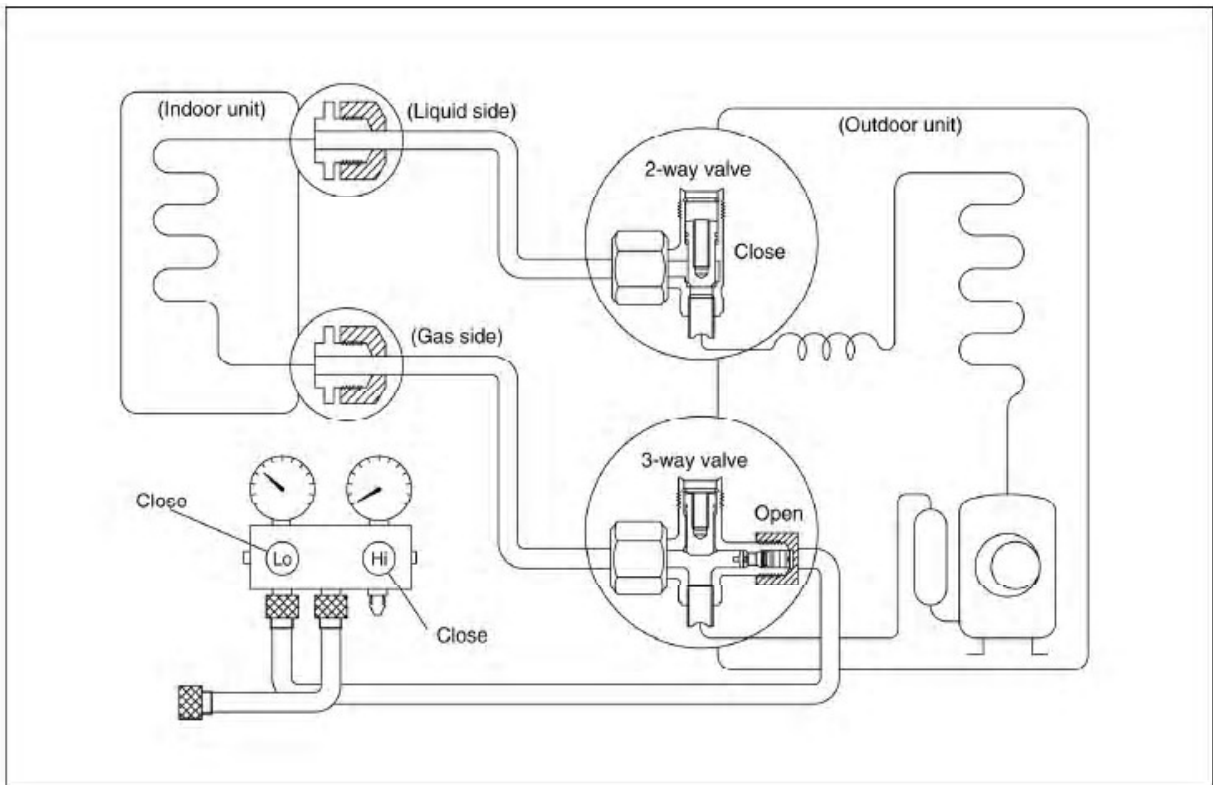

Procedure

1. Confirm that both the 2-way and 3-way valves are set to the opened position.
Remove the valve stem caps and confirm that the valve stems are in the opened position.
Be sure to use a hexagonal wrench to operate the valve stems.
2. Operate the unit for 10 to 15 minutes.
3. Stop operation and wait for 3 minutes, then connect the charge set to the service port of the 3-way valve.
Connect the charge hose with the push pin to the gas service port.
5. Air purging of the charge hose.
Open the low-pressure valve on the charge set slightly to purge air from the charge hose.
6. Set the 2-way valve to the close position.
7. Operate the air conditioner at the cooling cycle and stop it when the gauge indicates 0.1MPa.
8. Immediately set the 3-way valve to the closed position.
Do this quickly so that the gauge ends up indicating 0.3 to 0.5Mpa.
Disconnect the charge set, and amount the 2-way and 3-way valve's stem nuts and service port caps.
Use a torque wrench to tighten the service port cap to a torque of 1.8 kgf.m.
Be sure to check for gas leakage.

7.6 Re-air purging (Re-installation)

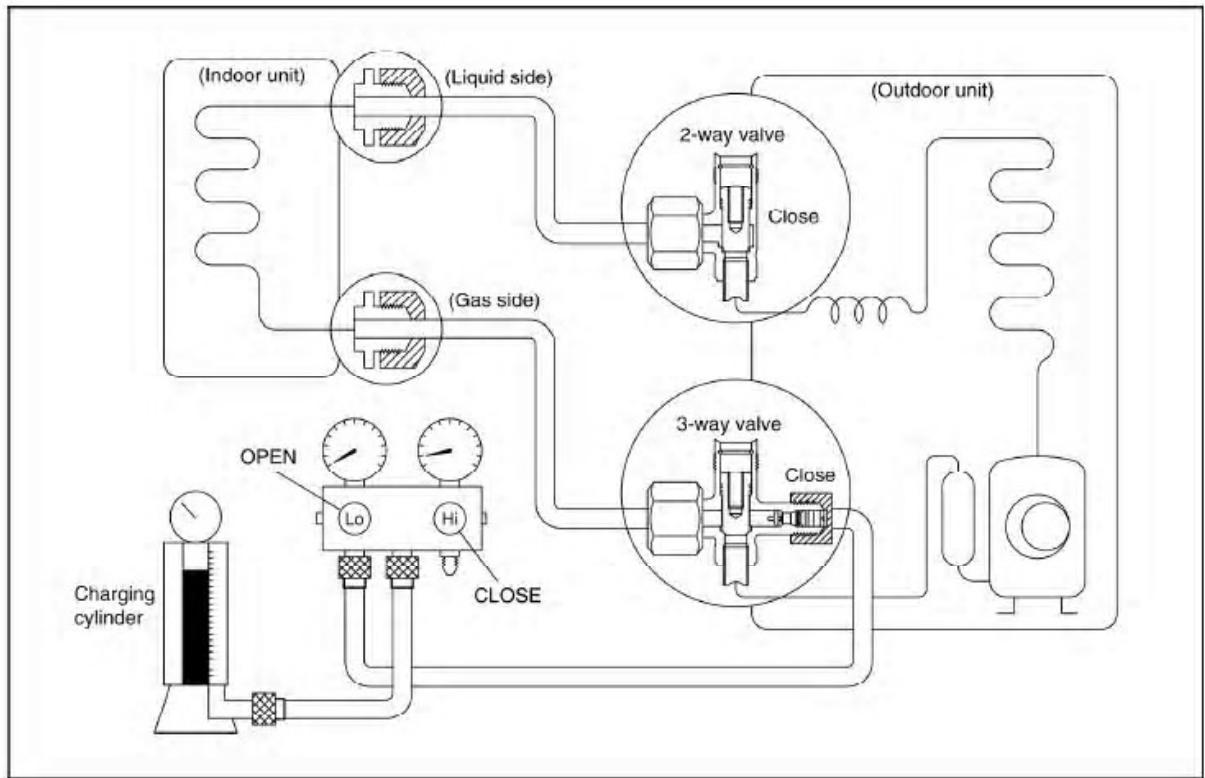

Procedure:

1. Confirm that both the 2-way and 3-way valves are set to the closed position.
2. Connect the charge set and a charging cylinder to the service port of the 3-way valve.
Leave the valve on the charging cylinder closed.
3. Air purging.
Open the valves on the charging cylinder and the charge set. Purge the air by loosening the flare nut on the 2-way valve approximately 45° for 3 seconds then closing it for 1 minute; repeat 3 times.
After purging the air, use a torque wrench to tighten the flare nut to on the 2-way valve.
4. Check the gas leakage.
Check the flare connections for gas leakage.
5. Discharge the refrigerant.
Close the valve on the charging cylinder and discharge the refrigerant until the gauge indicates 0.3 to 0.5 Mpa.
6. Disconnect the charge set and the charging cylinder, and set the 2-way and 3-way valves to the open position.
Be sure to use a hexagonal wrench to operate the valve stems.
7. Mount the valve stems nuts and the service port cap.
Be sure to use a torque wrench to tighten the service port cap to a torque 18N.m.
Be sure to check the gas leakage.

7.7 Balance refrigerant of the 2-way, 3-way valves

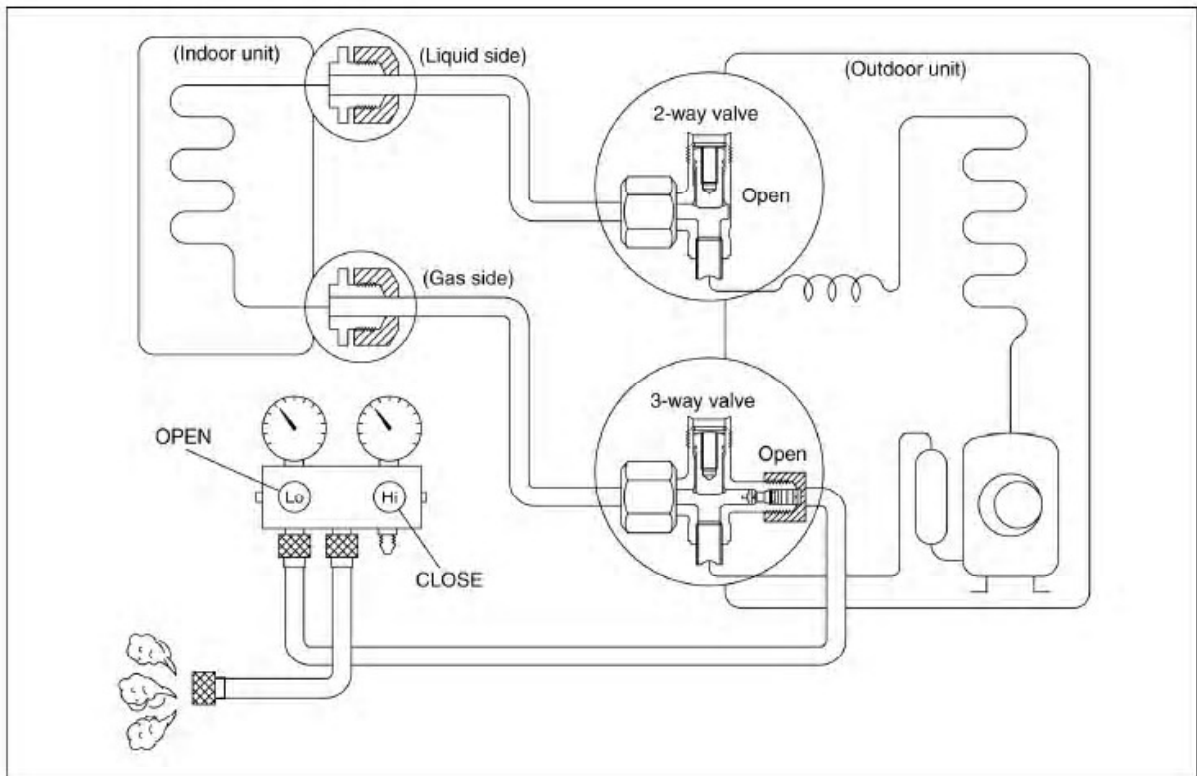

Procedure:

1. Confirm that both the 2-way and 3-way valves are set to the open position.
2. Connect the charge set to the 3-way valve's service port.
Leave the valve on the charge set closed.
Connect the charge hose with the push pin to the service port.
3. Open the valves (Low side) on the charge set and discharge the refrigerant until the gauge indicates 0.05 to 0.1Mpa.
If there is no air in the refrigeration cycle [the pressure when the air conditioner is not running is higher than 0.1Mpa, discharge the refrigerant until the gauge indicates 0.05 to 0.1 Mpa. If this is the case, it will not be necessary to apply an evacuation.
Discharge the refrigeration gradually; if it is discharged too suddenly, the refrigeration oil will be discharged.

7.8 Evacuation

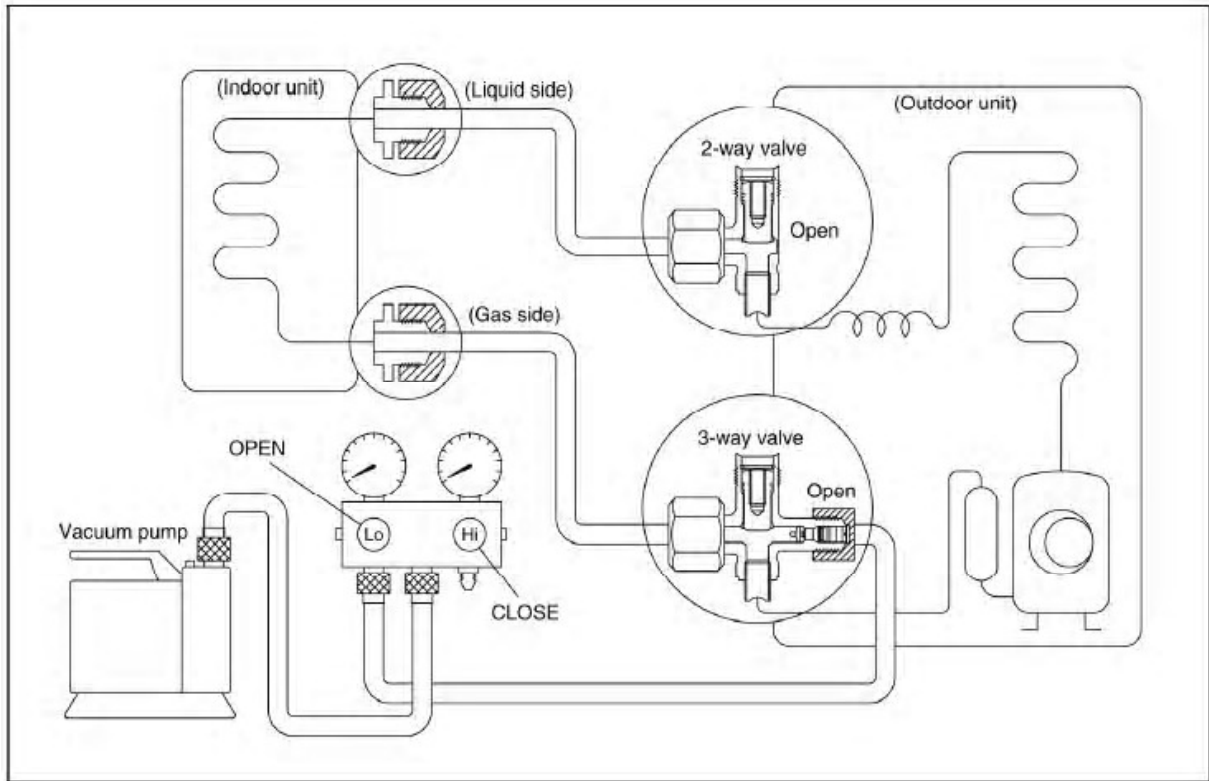

Procedure:

1. Connect the vacuum pump to the charge set's centre hose.
2. Evacuation for approximately one hour.
Confirm that the gauge needle has moved toward -0.1 Mpa (-76 cmHg) [vacuum of 4 mmHg or less].
3. Close the valve (Low side) on the charge set, turn off the vacuum pump, and confirm that the gauge needle does not move (approximately 5 minutes after turning off the vacuum pump).
4. Disconnect the charge hose from the vacuum pump.
Vacuum pump oil, if the vacuum pump oil becomes dirty or depleted, replenish as needed.

7.9 Gas charging

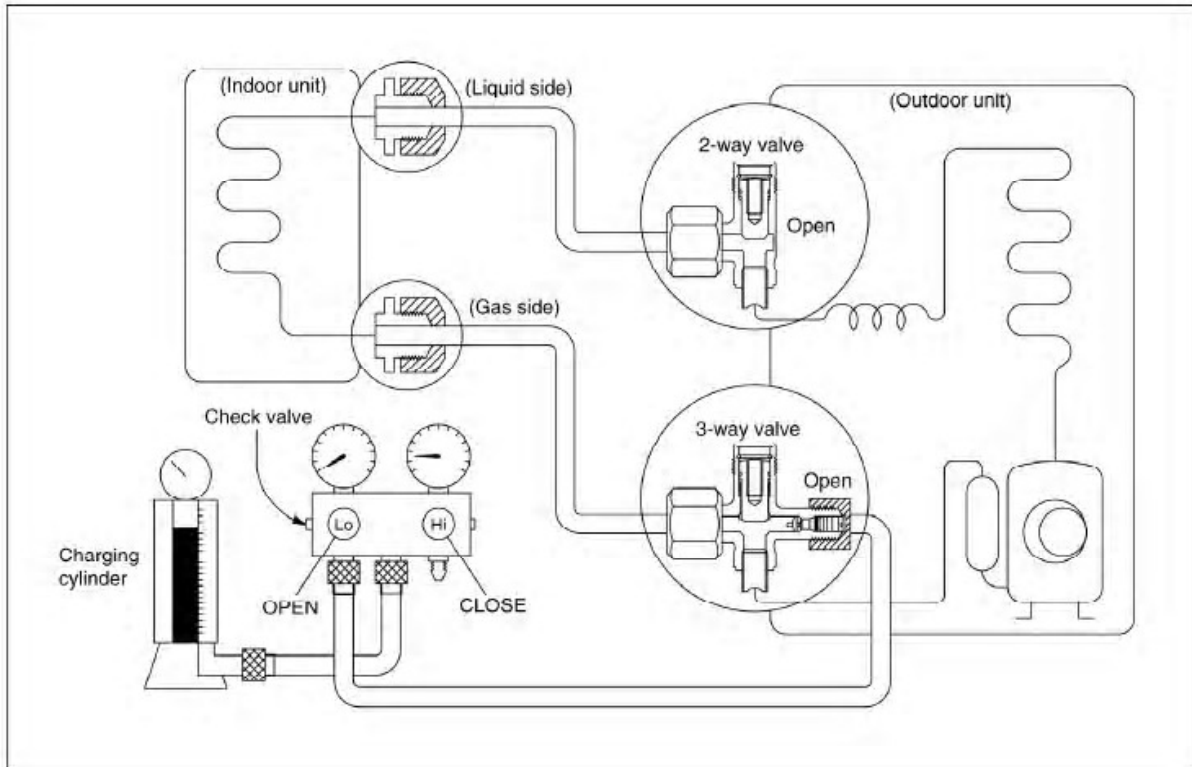

Procedure:

1. Connect the charge hose to the charging cylinder.
Connect the charge hose which you disconnected from the vacuum pump to the valve at the bottom of the cylinder.
2. Purge the air from the charge hose.
Open the valve at the bottom of the cylinder and press the check valve on the charge set to purge the air (be careful of the liquid refrigerant).
3. Open the valves (Low side) on the charge set and charge the system with liquid refrigerant.
If the system cannot be charge with the specified amount of refrigerant, it can be charged with a little at a time (approximately 150g each time) while operating the air conditioner in the cooling cycle; however, one time is not sufficient, wait approximately 1 minute and then repeat the procedure.(pumping down-pin).
4. Immediately disconnect the charge hose from the 3-way valve's service port.
Stopping partway will allow the refrigerant to be discharged.
If the system has been charged with liquid refrigerant while operating the air conditioner, turn off the air conditioner before disconnecting the hose.
5. Mounted the valve stem caps and the service port
Use torque wrench to tighten the service port cap to a torque of 18N.m.
Be sure to check for gas leakage.

8. Operation characteristics

8.1 MSC-09HRDN1-QC2(B)

Cooling Characteristics

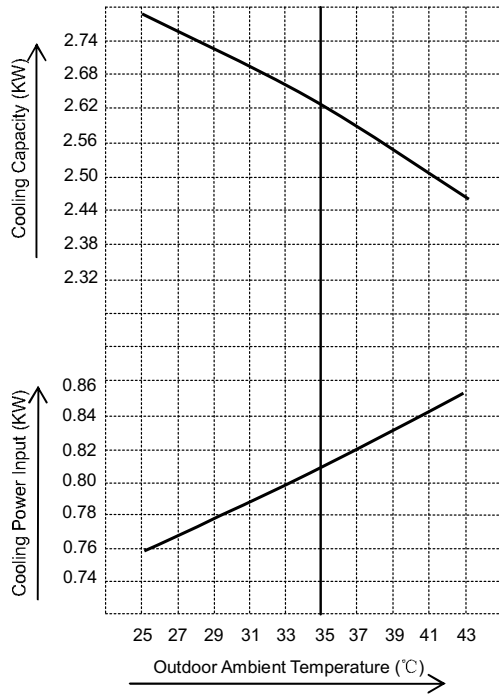

Remark: Indoor room temperature: 27/19°C
Indoor fan speed: High
Pipe length: 5m

Piping Length Characteristics (Cooling)

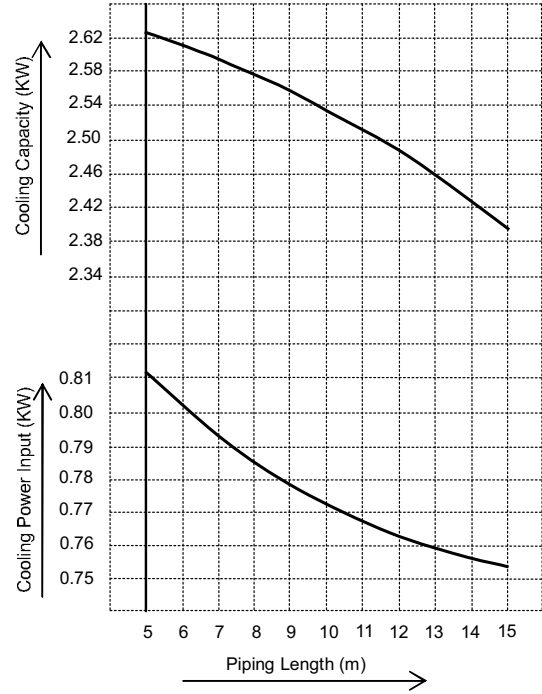

Remark: Indoor room temperature: 27/19°C
Outdoor temperature: 35°C
Indoor fan speed: High

Heating Characteristics

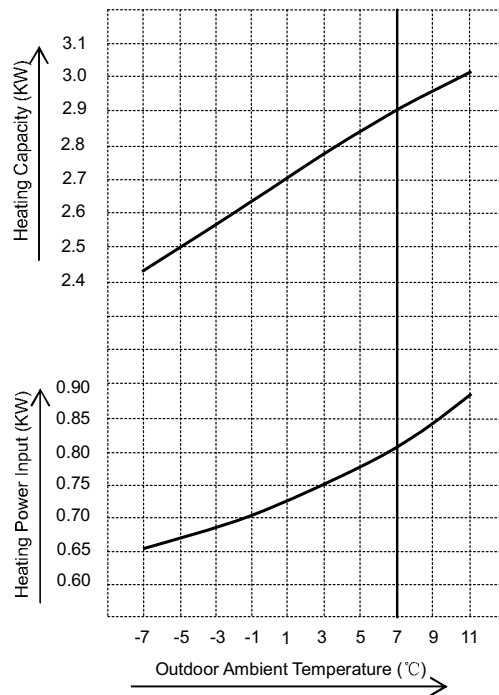

Remark: Indoor room temperature: 20°C
Indoor fan speed: High
Pipe length: 5m

Piping Length Characteristics (Heating)

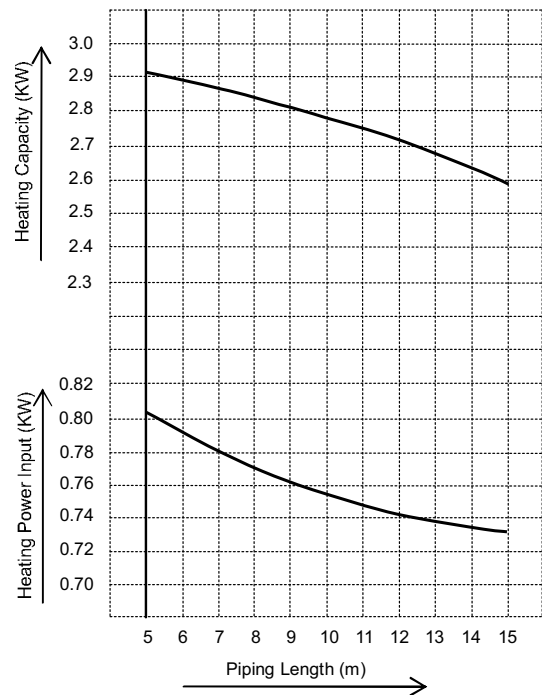

Remark: Indoor room temperature: 20°C
Outdoor temperature: 7/6°C
Indoor fan speed: High

8.2 MSC-12HRDN1-QC2(B)

Cooling Characteristics

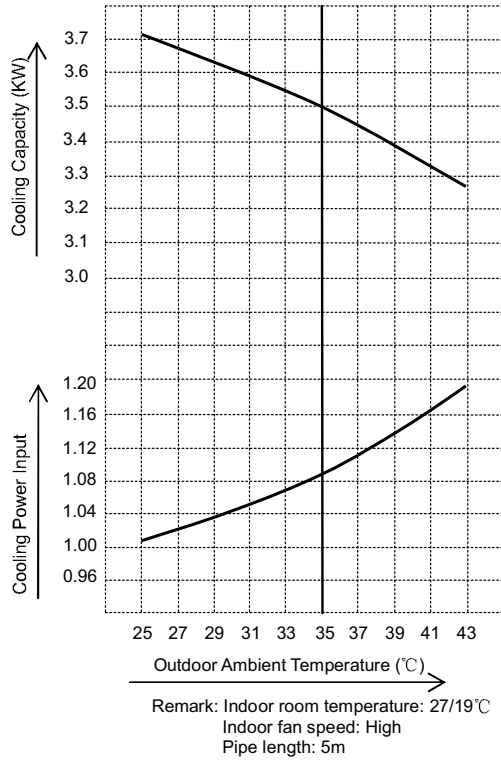

Piping Length Characteristics (Cooling)

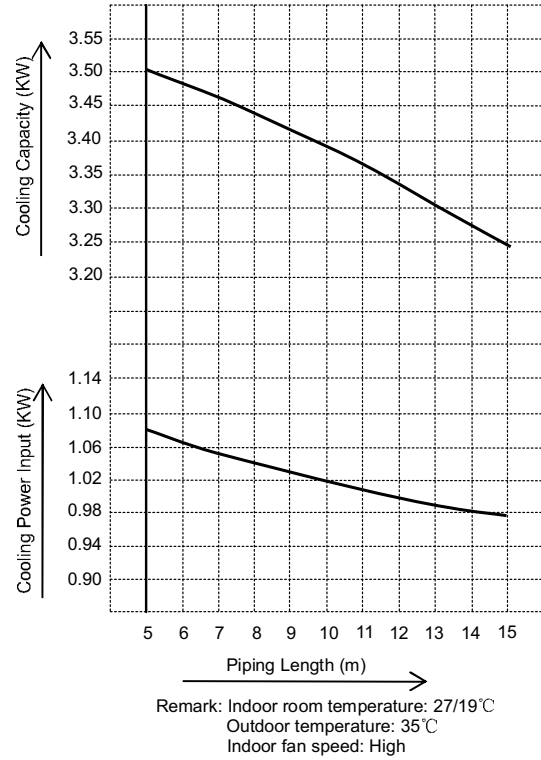

Heating Characteristics

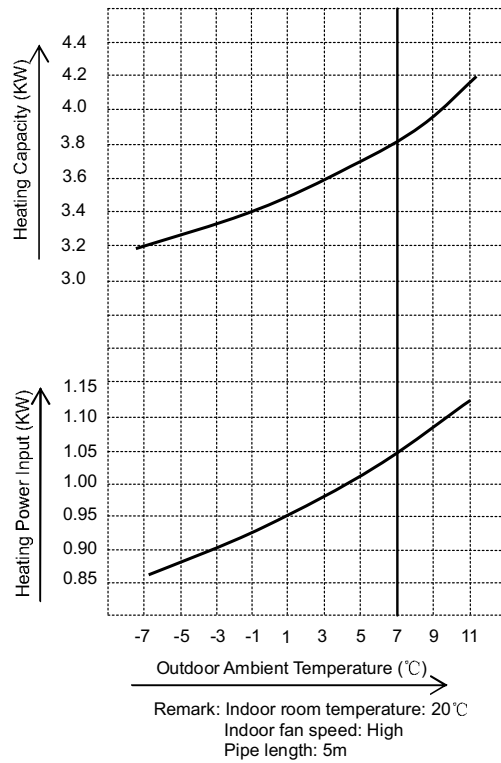

Piping Length Characteristics (Heating)

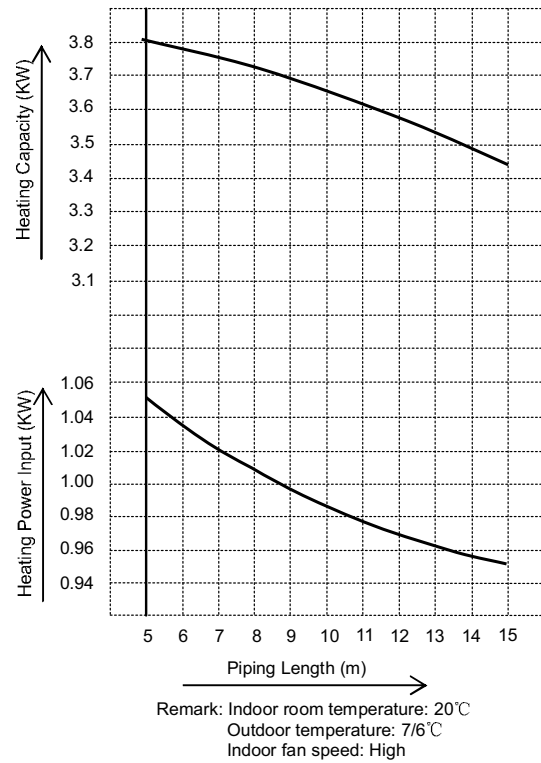

8.3 MSH-09HRDN1-QC2(B)

Cooling Characteristics

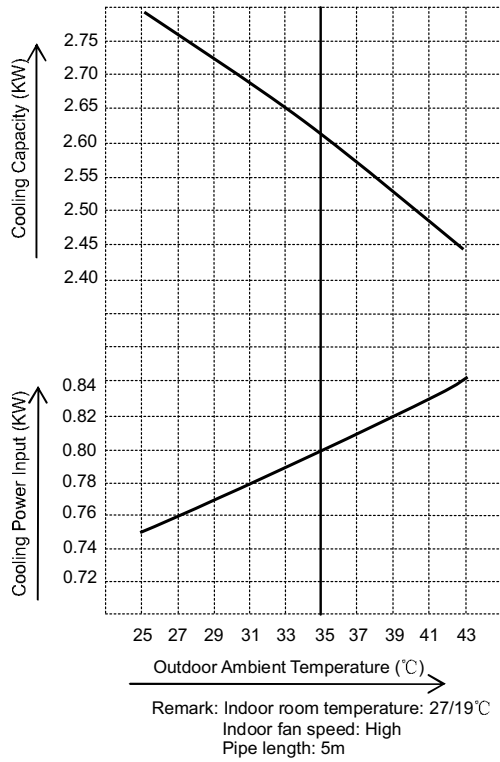

Piping Length Characteristics (Cooling)

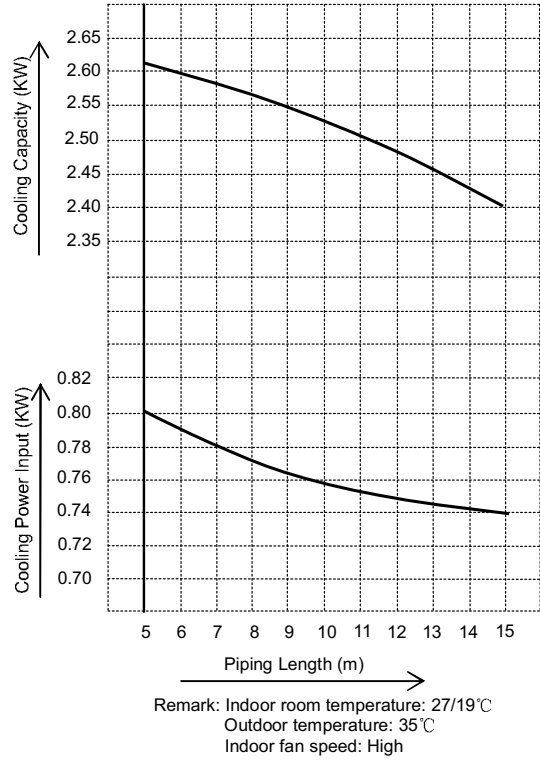

Heating Characteristics

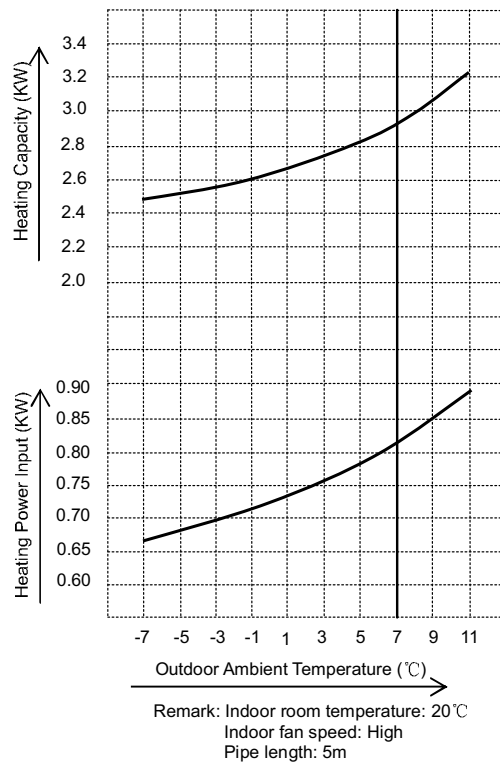

Piping Length Characteristics (Heating)

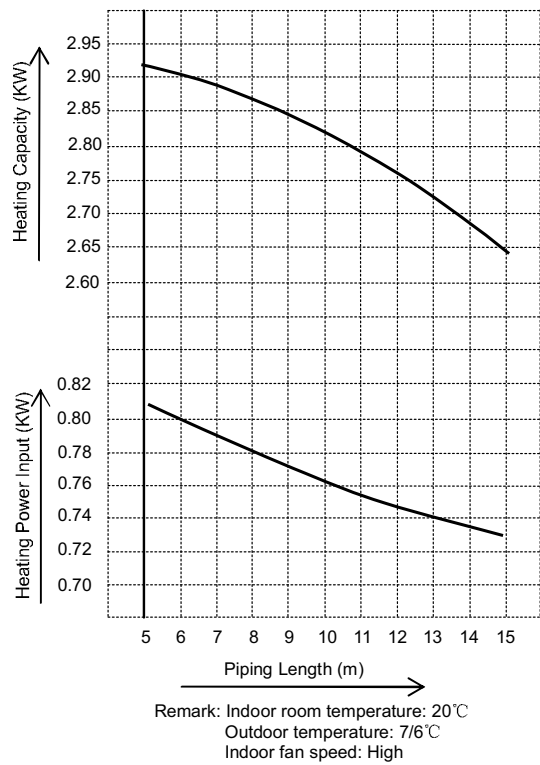

8.4 MSH-12HRDN1-QC2(B)

Cooling Characteristics

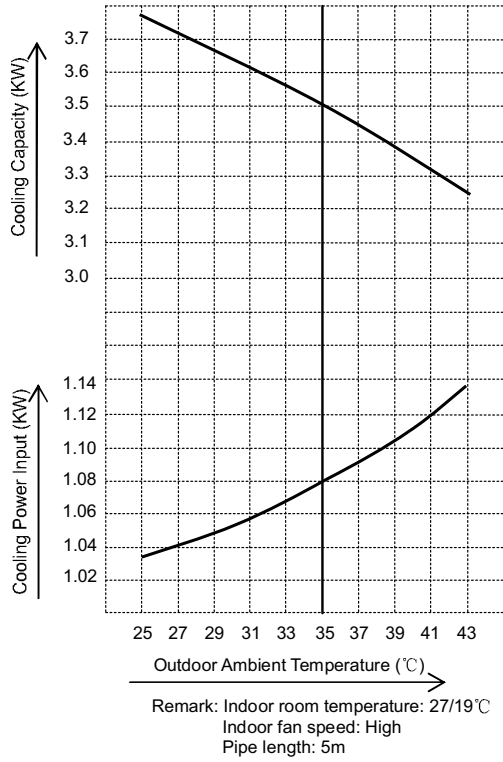

Piping Length Characteristics (Cooling)

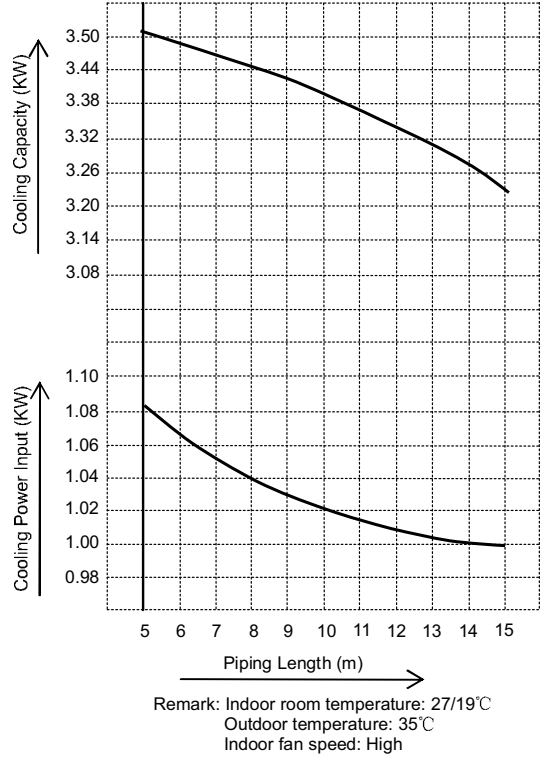

Heating Characteristics

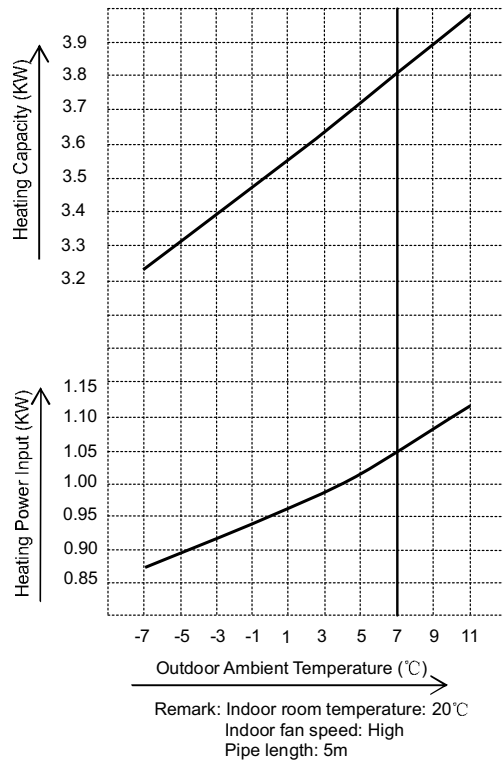

Piping Length Characteristics (Heating)

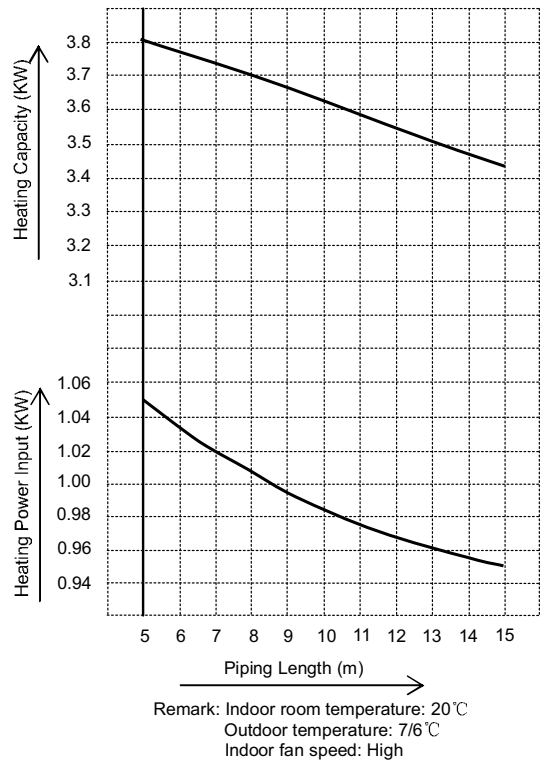

9. Electronic function

9.1 Abbreviation

- T1: Indoor ambient temperature
- T2: Pipe temperature of indoor heat exchanger
- T3: Pipe temperature of outdoor heat exchanger
- T4: Outdoor ambient temperature

9.2 Display function

9.2.1 Icon explanation on indoor display board.

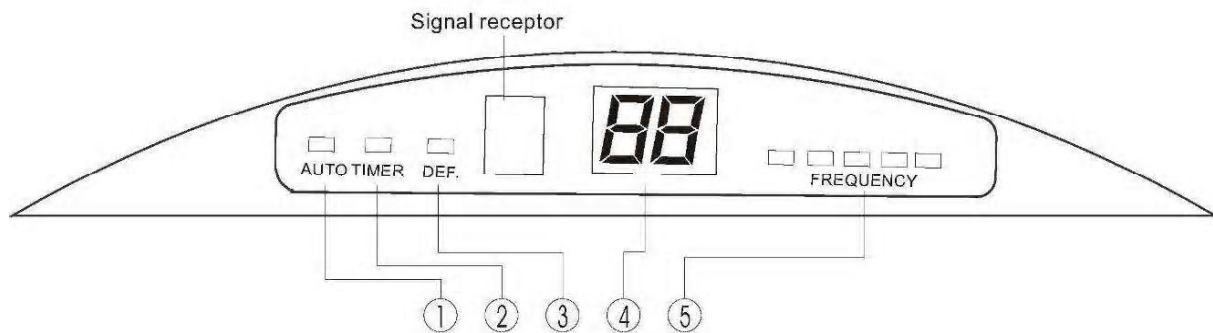

MSC-09HRDN1-QC2(B) MSC-12HRDN1-QC2(B)

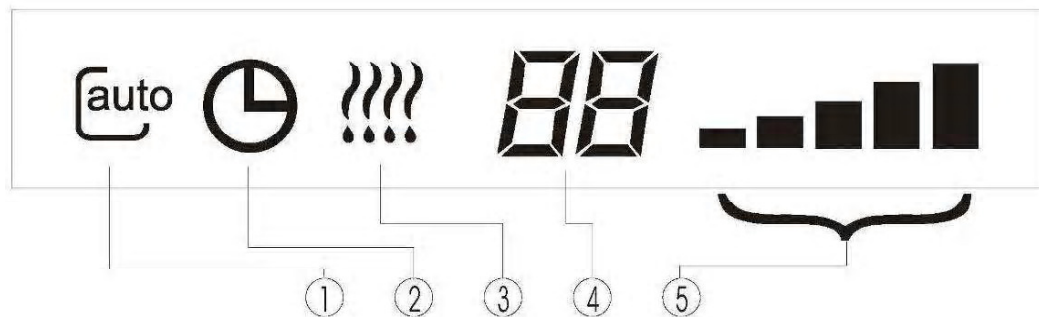

MSH-09HRDN1-QC2(B) MSH-12HRDN1-QC2(B)

- ① Auto indicator
This indicator illuminates when the air conditioner is in AUTO operation.
- ② Timer indicator
This indicator illuminates when TIMER is set ON/OFF.
- ③ PRE.-DEF. Indicator
This indicator illuminates when the air conditioner starts defrosting automatically or when the warm air control feature is activated in heating mode.
- ④ TEMPERATURE indicator
Usually it displays the temperature settings. When change the setting temperature, this indicator begins to flash, and stops 20 seconds later.
It displays the room temperature when the air conditioner is in FAN only operation, and the range of that is 0~50°C. When the unit stops operation, it returns to original factory settings.
Displays the malfunction code or protection code.
- ⑤ Frequency indicator
This indicator appears only when the compressor is in operation and indicates the current operating frequency.

9.2.2 LED display control function.

Pressing "LED display" button on remote controller will turn off all displays on indoor unit, while pressing once again, all displays will resume.

9.3 Protection

9.3.1 Three Minutes Delay at restart for compressor.

9.3.2 Temperature protection of compressor top.

9.3.3 If the temperature of compressor top is too high (higher than 115°C and the Over-load Protector is cut, the units stop. When the Over-load Protector restore and close (lower than 100°C), the compressor will restart (in this case the compressor is restricted by Three Minutes Delay protection).

9.3.4 Temperature protection of compressor exhaust.

If the exhaust temp. of compressor is higher than 115°C and lasts for 5 seconds, the compressor stops and does not resume until the exhaust temp. is lower than 90°C .

9.3.5 Inverter module Protection, Inverter module Protection itself has a protection function against current, voltage and temperature. If these protections happened, the corresponding code will display on indoor unit LED.

9.3.6 Sensor protection at open circuit and breaking disconnection

9.3.7 Fan Speed is out of control. When Indoor Fan Speed is too low (lower than 300RPM for 60 seconds), the unit stops and LED displays failure information and can't return to normal operation automatically.

9.3.8 Cross Zero signal error warning. If there are 20 alternations of Cross Zero signals are incorrect, the unit stops and LED displays failure information. After resuming, the motor rotates again. The spacing of Cross Zero signal is 6-13ms.

9.3.9 Indoor fan delayed open function

9.3.10 For all modes, when the units are turned on, the indoor fan can operate 10 seconds after the action of louver.

9.3.11 Compressor preheating function.

1) Preheating permitting condition:

If T_4 (outdoor ambient temperature) $< 3^{\circ}\text{C}$ and the machine connects to power supply newly or if $T_4 < 3^{\circ}\text{C}$ and compressor has stopped for over 3 hours, the compressor heating cable will work.

2) Preheating mode:

A weak current flows through the coil of compressor from the wiring terminal of compressor, then the compressor is heated without operation.

3) Preheating release condition:

If $T_4 > 5^{\circ}\text{C}$ or user turns on the machine and compressor runs, preheating function will stop.

9.3.12 Compressor heating cable

If outdoor temperature (sensed by outdoor thermostat) is lower than 5°C , the thermostat closes and compressor heating cable begins to work. If outdoor temperature is higher than 15°C , the thermostat opens and compressor heating cable stopping working.

9.4 Fan-Only Mode

9.4.1 Temperature setting function is disabled, and no setting temperature display.

9.4.2 In this mode, the action of louver is the same as in cooling mode.

9.4.3 The action of auto fan in fan-only mode is the same as auto fan in cooling mode with 24°C setting temperature.

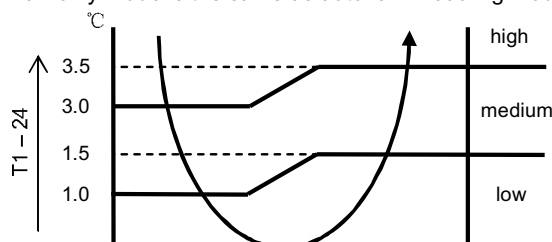

9.5 Cooling Mode

9.5.1 After start the operation frequency of compressor submits to following rule.

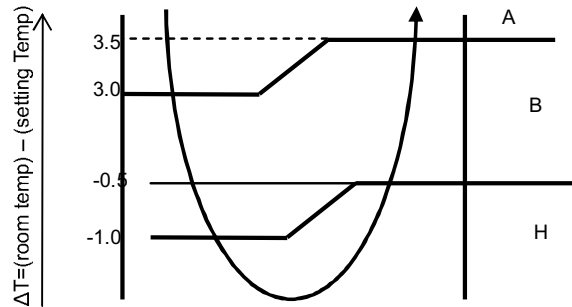

When the machine is running and ΔT (=room temp. – setting temp.) changes, the frequency of compressor will rise or descend a grade (7 minutes after starting).

After start, if ΔT stays in a zone for 3 minutes, the frequency will change as follow:

Zone A : Current frequency rise a grade till the maximum grade.

Zone B: Elevate or keep or descend the frequency of compressor.

Zone H: Compressor stops after running as the minimum frequency for 60 minutes or ΔT is less than -2°C .

9.5.2 Indoor heat exchanger anti-freezing function.

If T_2 is lower than 0°C , the compressor stops and resumes when $T_2 > 5^{\circ}\text{C}$.

9.5.3 Outdoor unit current control in cooling mode(refer to the parameter table)

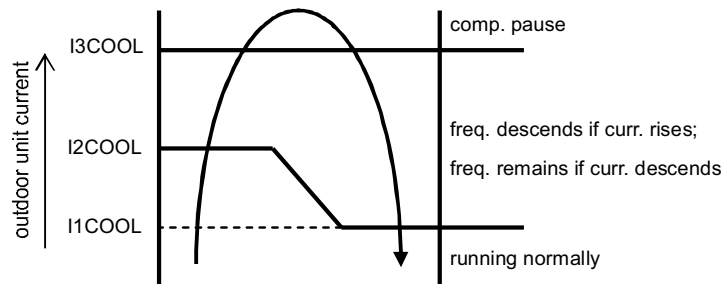

Remark:

	I1COOL	I2COOL	I3COOL
9K Model	5.0 A	6.5 A	7.5 A
12K Model	5.5A	7.0 A	7.8 A

9.5.4 Rating capacity test function

- 1) Set the indoor unit with remote controller as: high fan, 17°C in cooling mode, then press "TURBO" button on controller 6 times or more within 10 seconds(make sure indoor unit receives these signals), the machine will turn into rating capacity test mode, the buzzer will make a "di" sound for 2 seconds continuously. Also, indoor fan will change to rating speed, the frequency of compressor will be fixed as rating value. Any condition of above is not satisfied, the machine can not be turned into rating capacity test mode.
- 2) The machine will quit from the rating capacity test mode if running for 5 hours or changing fan speed or setting temperature.

9.5.5 Turbo function (press the "TURBO" button on remote controller)

- 1) Elevate current frequency to a higher grade.
- 2) Indoor fan turns to turbo speed.
- 3) After running for 30 minutes the machine will turn back to previous setting mode.

9.5.6 Indoor fan operation rule.

- 1) In cooling mode, indoor fan runs all the time and the speed can be selected as high, medium, low and auto.
- 2) Auto fan in cooling mode acts as follow:

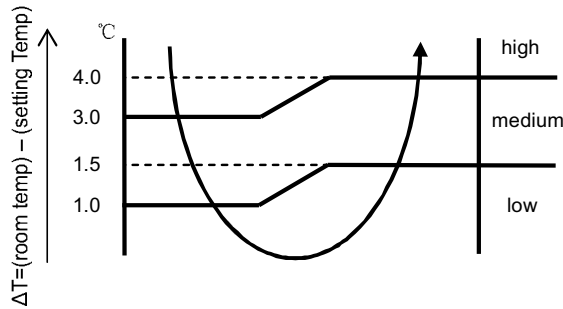

9.5.7 Condenser high temperature protection function (in cooling and drying mode)

If $T_3 > 60^{\circ}\text{C}$ for 5 seconds, compressor will stop immediately, and the machine will not resume until $T_3 < 52^{\circ}\text{C}$.

9.6 Drying mode

9.6.1 Indoor fan speed is fixed at breeze grade and can't be changed. The horizontal angle is the same as in cooling mode.

9.6.2 Room overflow temperature protection

In drying mode, if room temperature is lower than 10°C , compressor will stop and not resume until room temperature climbs up to 12°C .

9.6.3 Evaporator anti-freezing protection, condenser high temperature protection and outdoor unit frequency limit are valid, and they are the same as that in cooling mode.

9.6.4 Horizontal louver action is the same as that in cooling mode.

9.7 Heating mode

9.7.1 Indoor fan action:

- 1) Anti-cold-wind function.

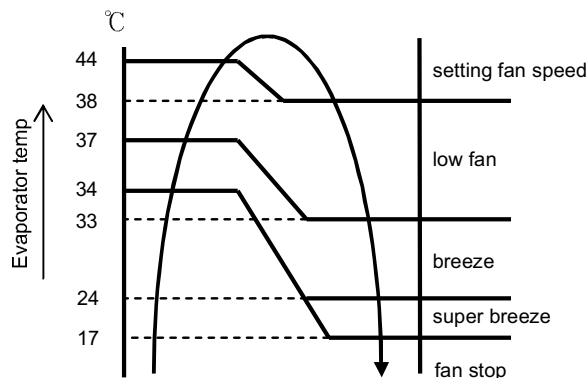

2) If the compressor stops caused by room temperature rising, indoor fan will be forced to run 127 seconds with breeze. During this period, anti-cold-wind is disabled. After this, anti-cold-wind function is available.

3) If the machine runs in rating capacity test mode, indoor fan runs with rating speed, and anti-cold-wind is disabled.

9.7.2 Indoor fan speed can be set as high, medium, low or auto grade, but anti-cold-wind function is preferential. Auto fan action in heating mode.

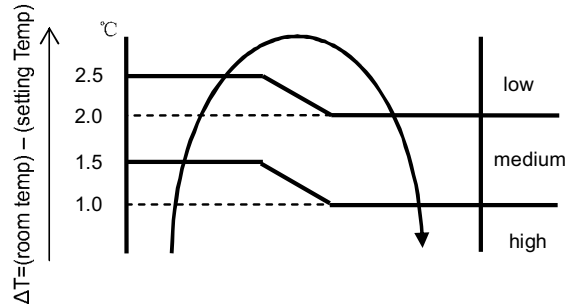

9.7.3 After start the operation frequency of compressor submits to following rule:

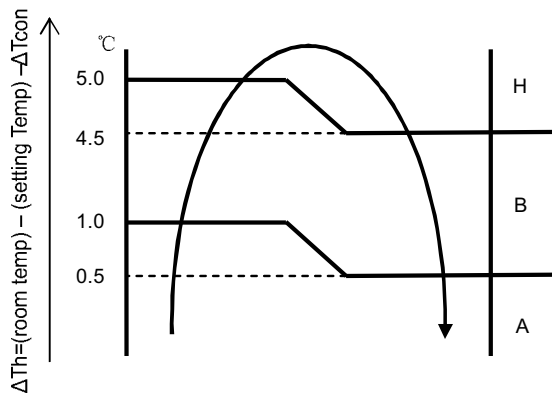

Remark: ΔT_{con} can be changed among 0, -2, -4°C, the default is 0°C

1) When the machine runs, if ΔT_h stays in a zone for 3 minutes, action of frequency is as follow:

Zone A: Elevate current frequency one grade, and not stop until the maximum grade.

Zone B: Elevate or keep or descend current frequency.

Zone H: Compressor stops after running with F1 for 60 minutes or when $\Delta T_h > 6^\circ\text{C}$.

2) Temperature difference (ΔT_{con}) choice.

After power on, the machine will self-diagnose, and if there are no J1 and J2 jump wires, ΔT_{con} will be set as 0°C.

J1	on	on	off	off
J2	on	off	on	off
$\Delta T_{con}(^\circ\text{C})$	0	-4	-2	0

9.7.4 Outdoor unit current control in heating mode.

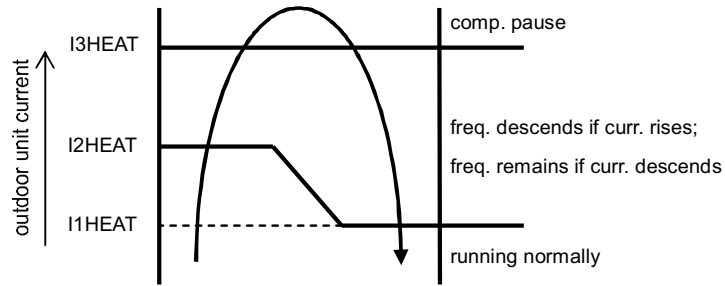

Remark:

	I1HEAT	I2 HEAT	I3 HEAT
9K Model	5.5 A	7.0 A	8.0A
12K Model	5.5 A	7.0 A	8.0 A

9.7.5 Indoor heat exchanger high temperature protection.

If $T_2 > 60^\circ\text{C}$, the compressor will stop and not resume until $T_2 < 48^\circ\text{C}$.

9.7.6 Defrosting mode.

1) Condition of defrosting.

Condition 1: If $T_4 > 0^\circ\text{C}$,

When the units are running, if the following two items are satisfied the units start defrosting:

- a) The units runs with $T_3 < 3^\circ\text{C}$ for 40 minutes and T_3 keeps lower than -6°C for more than 3 minutes.
- b) The units runs with $T_3 < 3^\circ\text{C}$ for 80 minutes and T_3 keeps lower than -4°C for more than 3 minutes.

Condition 2: If $T_4 < 0^\circ\text{C}$,

The program judges according to the condition 1, if the two items are satisfied, then judges if T_2 has descended for more than 5°C , if it has the machine starts defrosting, or continues to judge T_2 and will not defrost until T_2 drops more than 5°C .

Condition 3: No matter what value T_4 is, if the machine runs with $T_3 < 3^\circ\text{C}$ for more than 120 minutes and T_3 keeps lower than -2°C for more than 3 minutes, the machine will defrost, no matter if T_2 drops for more than 5°C or not.

2) Condition of ending defrosting.

If any one of following items is satisfied, defrosting will finish and the machine will turn to normal heating mode.

- a) T_3 rises to be higher than 12°C .
- b) T_3 rises to be higher than 8°C and remains for 80 seconds.
- c) The machine has run for 10 minutes in defrosting.

9.7.7 Defrosting action.

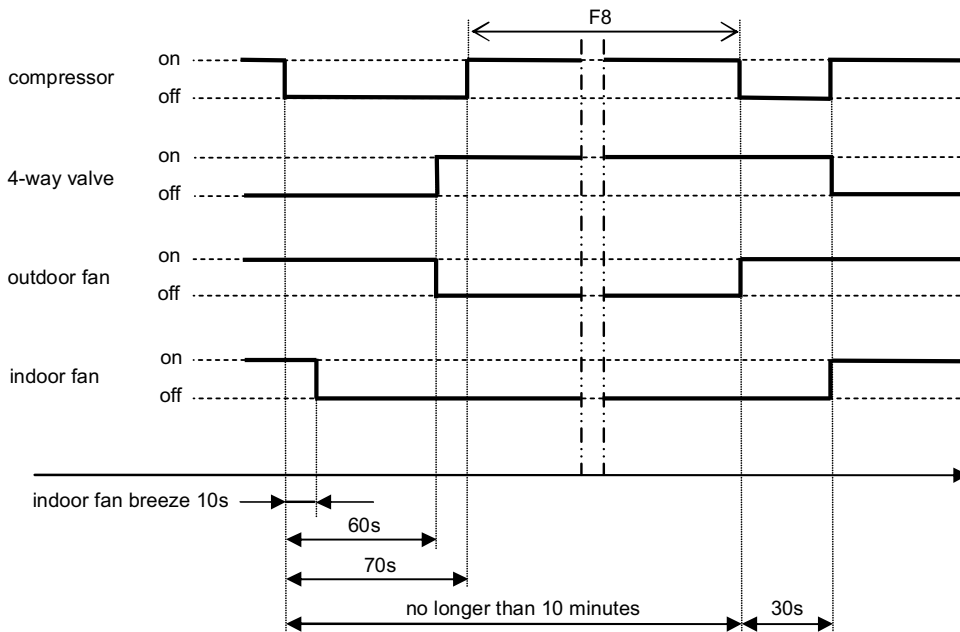

9.7.8 Rating capacity test function.

1) Set the indoor unit with remote controller as: high fan, 30°C in heating mode, then press “TURBO” button on controller 6 times or more within 10 seconds (make sure indoor unit receives these signals), the machine will turn into rating capacity test mode, the buzzer will make a “di” sound for 2 seconds continuously. Also, indoor fan will change to rating speed, the frequency of compressor will be fixed as rating value. Any condition of above is not satisfied, the machine can not be turned into rating capacity test mode.

2) The machine will quit from the rating capacity test mode if running for 5 hours or changing fan speed or setting temperature.

9.7.9 Turbo function in heating mode. (press the “TURBO” button on remote controller)

1) Elevate current frequency (excluding F8) to a higher grade. If indoor fan is in low speed or pause caused by defrosting or anti-cold-wind function, frequency of compressor will not be elevated one grade until these limit has been released.

2) Indoor fan changes to turbo speed and anti-cold-wind function is valid.

3) After running for 30 minutes the machine will turn back to previous setting mode.

9.8 Auto mode function

9.8.1 This mode can be chosen with remote controller and the setting temperature can be changed between 17~30°C.

In auto mode, the machine will choose cooling, heating or fan-only mode according to $\Delta T (\Delta T = T1 - Ts)$.

$\Delta T = T1 - Ts$	Running mode
$\Delta T > 1^\circ\text{C}$	Cooling
$-1 \leq \Delta T \leq 1^\circ\text{C}$	Fan-only
$\Delta T < -1^\circ\text{C}$	Heating

9.8.2 Indoor fan will choose auto speed of relevant mode.

9.8.3 If the machine switches mode between heating and cooling, compressor will keep stopping for 15 minutes and

then rechoose mode according to ΔT .

9.8.4 If the setting temperature is modified, the machine will rechoose running function.

9.9 Forced operation function

9.9.1 Forced cooling and auto function can carry out with a touch button. In these two modes, the machine can be changed by remote controller to any other mode at any moment.

9.9.2 When the machine is off, pressing the touch button will carry the machine to forced auto mode, after this, if pressing the button once again within 5 seconds, the machine will turn into forced cooling mode. In forced auto, forced cooling or any other operation mode, pressing touch button will turn off the machine. In forced operation, remote control is available.

9.9.3 In forced operation mode, all general protections is available.

9.9.4 In forced cooling mode, after running for 30 minutes. the machine will turn to normal auto mode which setting temperature is 24°C.

9.9.5 The action of forced auto mode is the same as normal auto mode which temperature is 24°C.

9.10 Action of 4-way valve

In heating, fan-only, standby or turning off mode, 4-way valve is off, while in cooling or drying mode 4-way valve is on. If the machine changes operation mode from cooling or drying mode to some other mode, 4-way valve will be delayed off 2 minutes after compressor stop. For defrosting, please refer to the passage “defrosting mode”.

9.11 Two speeds outdoor fan function

9.11.1 Outdoor fan starts at the same time with compressor, but stops 30 seconds later after compressor stop.

9.11.2 Outdoor fan action in heating mode(including heating in auto mode).

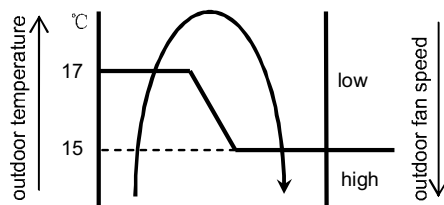

Outdoor fan action in heating mode (including heating in auto mode).

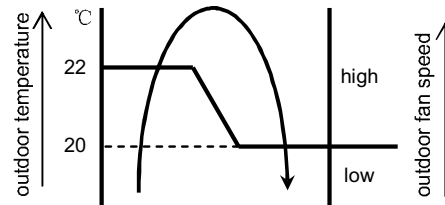

Outdoor fan action in cooling & drying mode (including cooling in auto & forced mode).

9.11.3 Outdoor fan action in cooling & drying mode(including cooling in auto & forced mode).

Please refer to the pic. above.

9.12 Timer function

9.12.1 Timing range is 24 hours, and the minimum resolution is 15 minutes.

9.12.2 Timer on. After turning off, the machine will turn on automatically when reaching the setting time.

9.12.3 Timer off. After turning on, the machine will turn off automatically when reaching the setting time.

9.12.4 Timer on/off. After turning off, the machine will turn on automatically when reaching the setting “on” time, and then turn off automatically when reaching the setting “off” time.

9.12.5 Timer off/on. After turning on, the machine will turn off automatically when reaching the setting “off” time, and then turn on automatically when reaching the setting “on” time.

9.12.6 The tolerance of timer is 1 minute per hour.

9.13 Sleep function mode

- 9.13.1 Operation time in sleep mode is 7 hours. After 7 hours the machine quits this mode and turns off.
- 9.13.2 In cooling, heating or auto mode sleep function is available.
- 9.13.3 Operation process in sleep mode is as follow:
- 1) After pressing ECONOMIC or SLEEP button on controller, the machine will turn into sleep mode.
 - 2) When cooling, the setting temperature rises 1°C (be lower than 30°C) every one hour, 2 hour later the rising stops and indoor fan is fixed as low speed.
 - 3) When heating, the setting temperature descends 1°C (be lower than 30°C) every one hour, 2 hour later the descending stops and indoor fan is fixed as low speed, and anti-cold-wind is available.
- 9.13.4 If user uses timer on function in sleep mode, sleep function will pause and not resume until reaches the setting on time.
- 9.13.5 When user uses timer off function in sleep mode (or sleep function in timer off mode), if the timing time is less than 7 hours, sleep function will be cancelled when reaching the setting time. If the timing time is more than 7 hours, the machine will not stop until reaches the setting off time in sleep mode.

9.14 Auto-Restart function

The indoor unit is equipped with auto-restart function, which is carried out through an auto-restart module. In case of a sudden power failure, the module restores the setting conditions before the power failure. The unit will resume the previous operation setting (not including Swing function) automatically after 3 minutes when power returns.

9.15 Ionizer/Plasma dust collector function(optional)

The indoor unit is equipped with Ionizer, which is controlled by the CLEAN AIR button on the remote controller when the unit is turned on. Press the CLEAN AIR button to activate the function. Press it again to stop the function. During the time when Ionizer being controlled by remote controller, Ionizer will be turned off automatically, if indoor fan stops running due to malfunctions or anti-cold-wind. When indoor fan restarts after malfunctions being eliminated and anti-cold-wind being released, Ionizer will be available again.

9.16 Outdoor chassis heating cable (optional)

Heating cable is fixed on outdoor chassis to help deicing and to avoid freezing. The heating cable's power is 85W, rated voltage is 220v-240v, and is controlled by the program. If outdoor temperature is lower than 5°C, the heating cable begins to work. If outdoor temperature is higher than 15°C, the heating cable stops working.

10. Troubleshooting

Safety

Because of there are capacitors in PCB and relative circuit in outdoor unit, even shut down the power supply, electricity power still are kept in capacitors, do not forget to discharge the electricity power in capacitor.

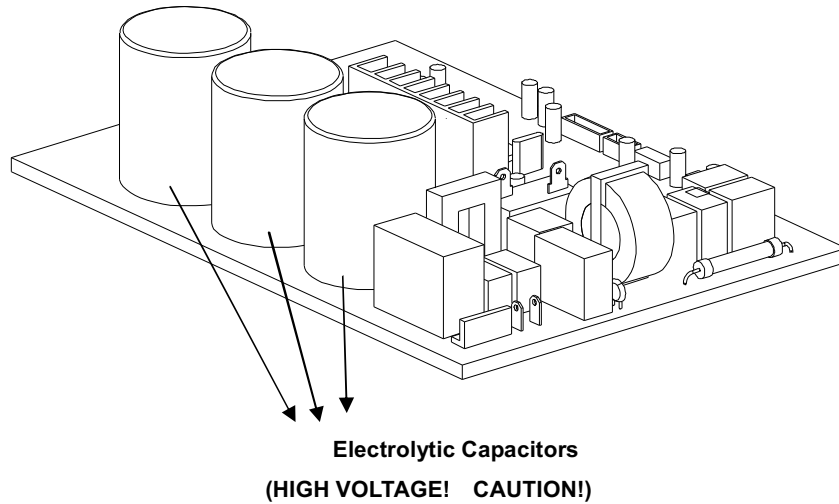

Bulb (25-40W)

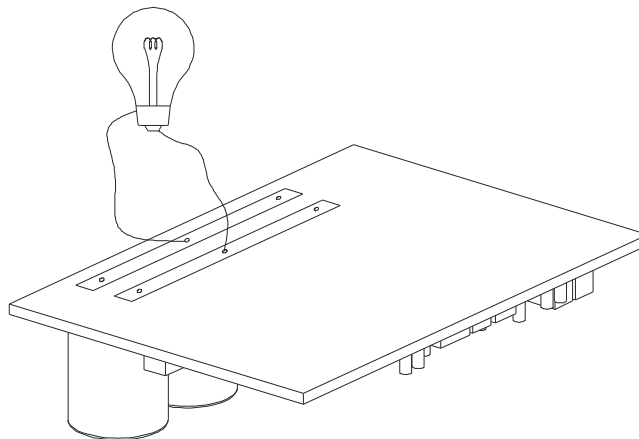

10.1 Indoor Unit Error Display

Display	LED STATUS
E0	EEPROM parameter error
E1	Indoor / outdoor units communication protection
E2	Zero-crossing signal error
E3	Fan speed out of control
E5	Open or short circuit of outdoor temperature sensor
E6	Open or short circuit of room or evaporator temperature sensor
P0	IGBT over-strong current protection
P1	Over voltage or too low voltage protection
P2	Temperature protection of compressor top.
P4	Inverter compressor drive error

Note: E4 & P3: Reserved function

10.2 Diagnosis and Solution

10.2.1 E0(EEPROM parameter error) error diagnosis and solution

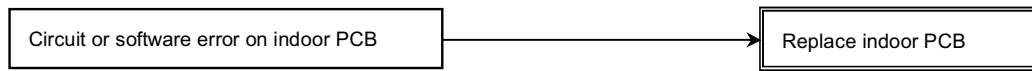

10.2.2 E1(indoor / outdoor units communication protection) error diagnosis and solution

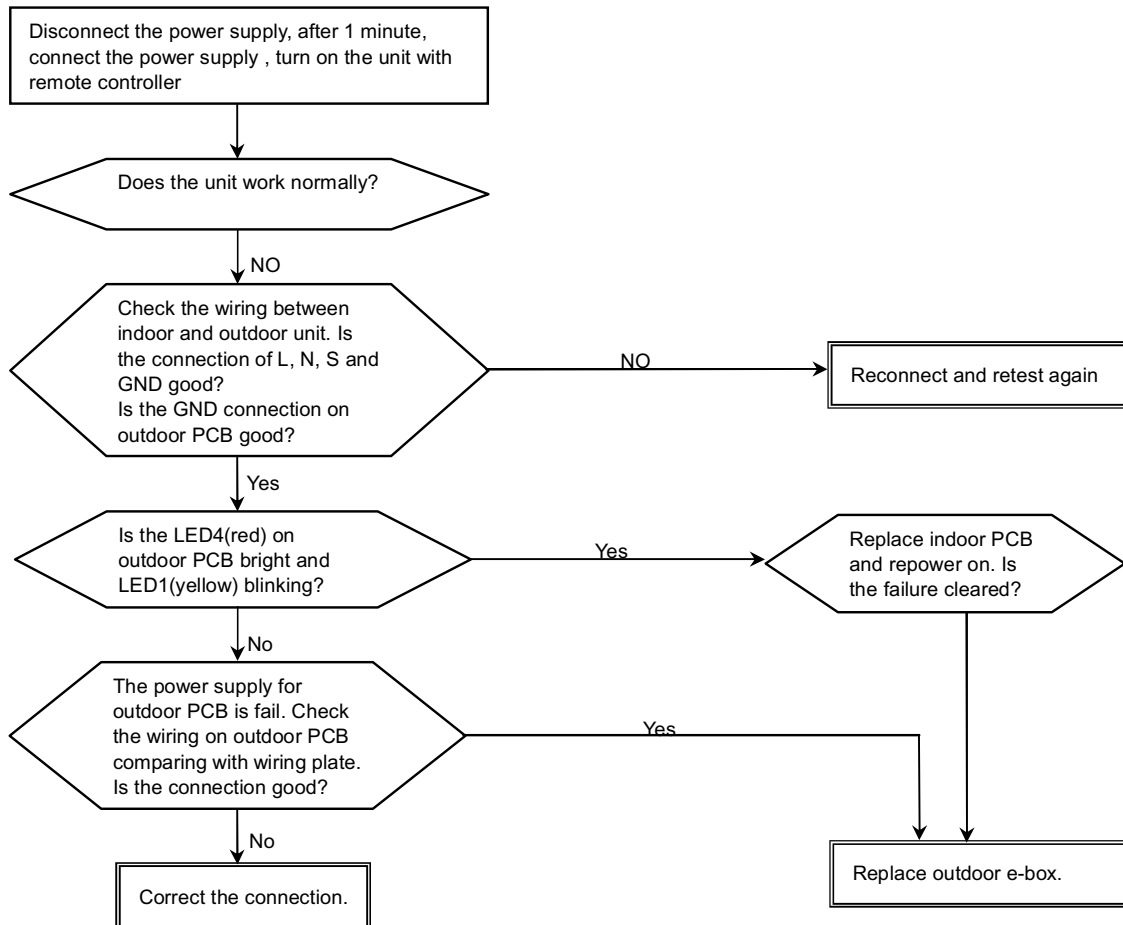

10.2.3 E2(zero-crossing signal error) diagnosis and solution

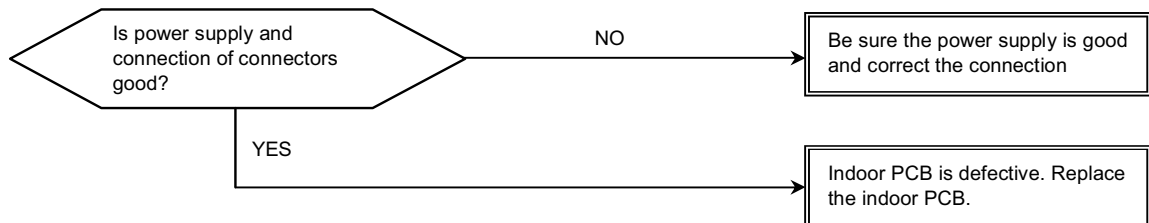

10.2.4 E3(indoor fan speed out of control) diagnosis and solution

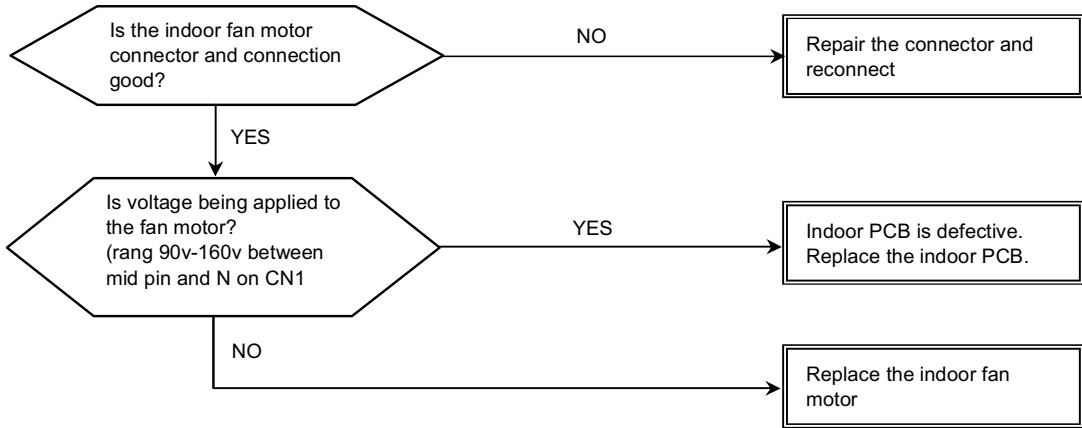

10.2.5 E5(Open or short circuit of outdoor temperature sensor) diagnosis and solution.

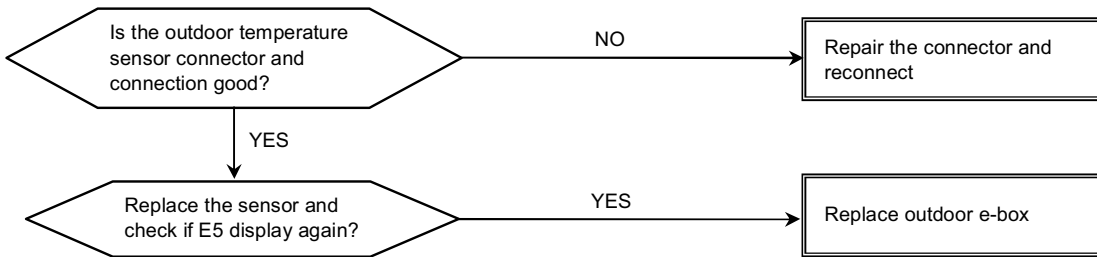

10.2.6 E6(open or short circuit of room or evaporator temperature sensor) diagnosis and solution.

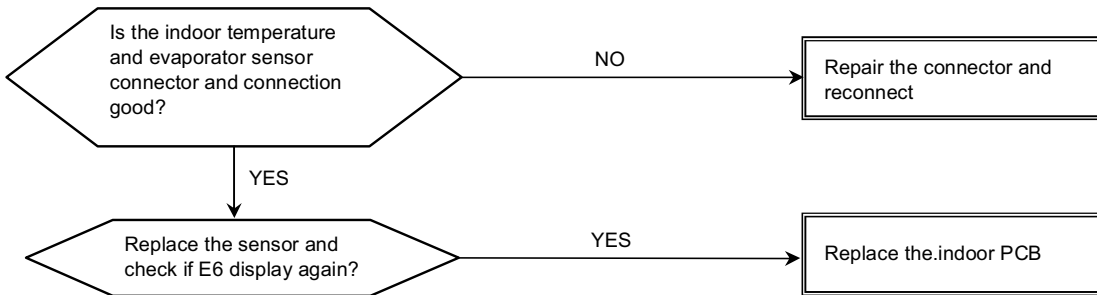

10.2.7 P0(IGBT over-strong current protection) diagnosis and solution.

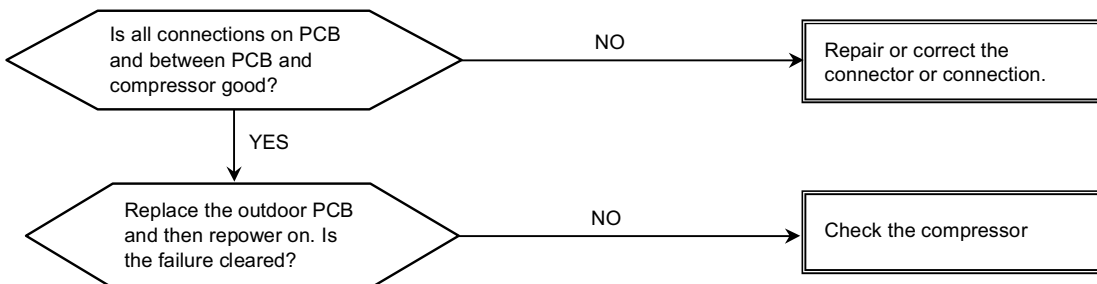

10.2.8 P1(over voltage or too low voltage protection) diagnosis and solution.

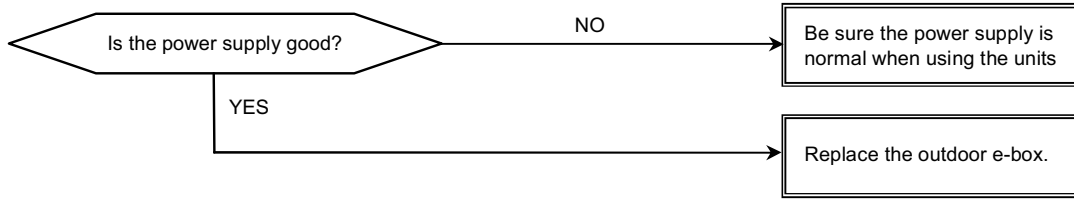

10.2.9 P2(temperature protection of compressor top) diagnosis and solution.

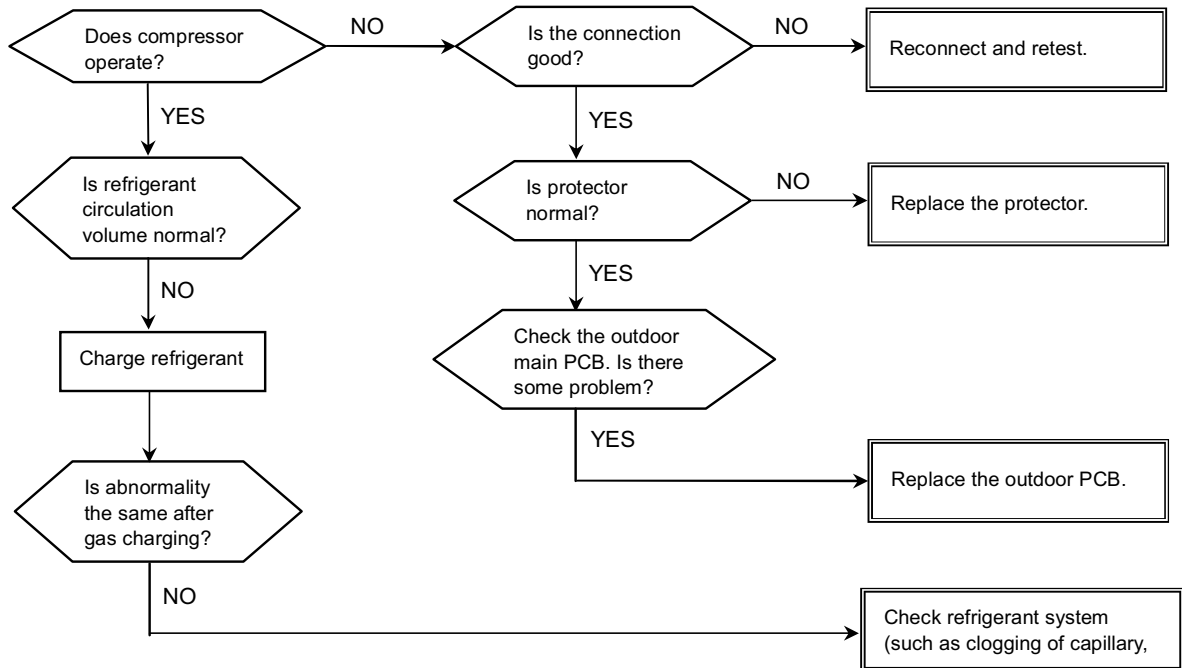

10.2.10 P4(inverter compressor drive error) diagnosis and solution.

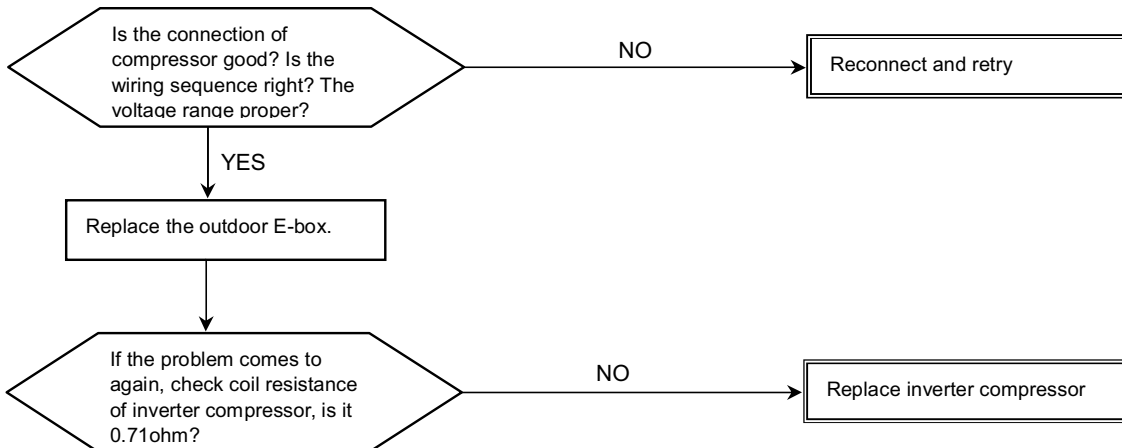

10.3 Key parts checking.

10.3.1. Compressor checking (Model: DA108X1C-20FZ3).

Measure the resistance value of each winding by using the multi-meter.

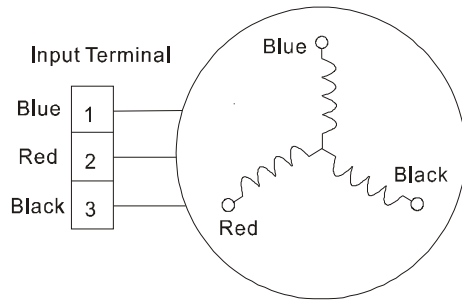

Position	Resistance Value
Blue - Red	0.71Ω (20 °C)
Blue - Black	
Red - Blue	

10.3.2 Outdoor Fan Motor (Model: YDK24-6G).

Measure the resistance value of each winding by using the multi-meter.

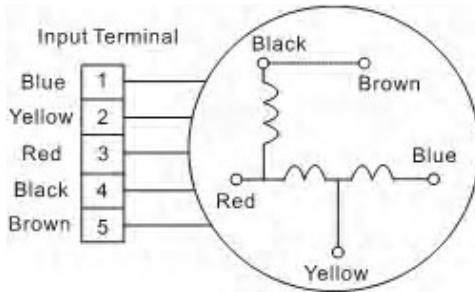

Position	Resistance Value
Black - Red	435Ω (20 °C)
Blue - Red	213Ω (20 °C)
Yellow - Blue	138Ω (20 °C)

10.3.3 Indoor Fan Motor (Model:RPG18H for MSC(H)-09HRDN1-QC2(A), RPG20D for MSC(H)-12HRDN1-QC2(A)).

Measure the resistance value of each winding by using the multi-meter.

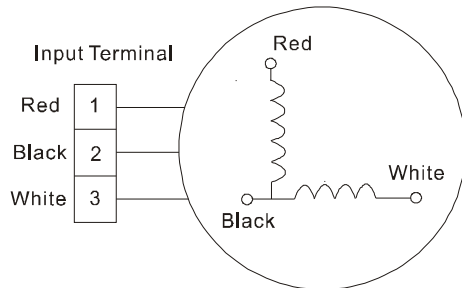

Position	Resistance Value
Black - Red	375Ω±8% (20 °C) for RPG18H 415Ω±8% (20 °C) for RPG20D
White - Black	377Ω±8% (20 °C) for RPG18H 290Ω±8% (20 °C) for RPG20D

10.3.4 Step Motor (Model: MP2835).

Measure the resistance value of each winding by using the multi-meter.

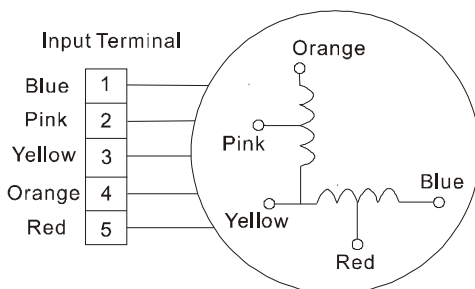

Position	Resistance Value
Blue - Red	200Ω±7% (25 °C)
Pink - Orange	
Pink - Yellow	
Yellow - Red	

10.3.5 Temperature Sensors.

Room temp.(T1) sensor,

Indoor coil temp.(T2) sensor,

Outdoor coil temp.(T3) sensor,

Outdoor ambient temp.(T4) sensor,

Compressor exhaust temp.(Te) sensor.

Measure the resistance value of each winding by using the multi-meter.

Some frequently-used R-T data for T1,T2,T3 and T4 sensor:

Temperature (°C)	5	10	15	20	25	30	40	50	60
Resistance Value (KΩ)	26.9	20.7	16.1	12.6	10	8	5.2	3.5	2.4

Some frequently-used R-T data for Te sensor:

Temperature (°C)	5	15	25	35	60	70	80	90	100
Resistance Value (KΩ)	141.6	88	56.1	36.6	13.8	9.7	6.9	5	3.7

